

Supereta™ iQN Series DC/DC Power Modules
48V Input, 28V / 7A Output
Quarter Brick

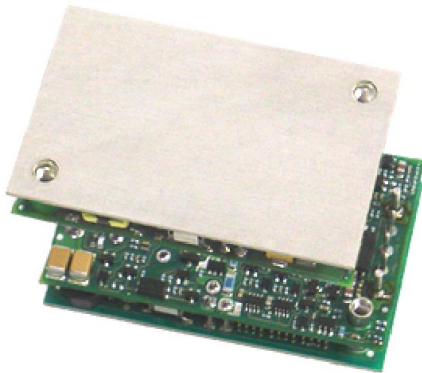

The Supereta™ iQN series offers an industry standard quarter brick high power module with true useable output power. The iQN series power modules with the voltage foldback constant current limit feature are ideally suited for wireless applications to power the amplifiers. Its 92% full load efficiency (92.5% at 70% of full load) and superior thermal performance make the iQN series of power modules ideally suited for tight space and power-hungry applications in demanding thermal environments. This rugged building block is designed to serve as the core of your high reliability system. The droop current sharing capability makes multiple modules connected in parallel to be possible. A wide output voltage trim range; from 60% to +110%, remote sensing, and remote on/off control are standard features enhancing versatility.

Standard Features:

- Standard Quarter Brick Pinout
- Size: 2.28" × 1.45" × 0.5"
(57.9mm × 36.8mm × 12.7mm)
- Up to 7A of output current
- Power density > 118W / in³
- Efficiency – up to 93.5%
- Full load typical efficiency – 92%
- Output power – 196W
- Droop load share with 0.125V/A
- Wide output trim range, 17V to 30.8V
- Metal board design with high usable power
7.0A at 60C, 350LFM
5.6A at 65C, 200LFM
- Basic insulation – 1500Vdc
- Positive remote on/off logic
- Remote sense
- Constant switching frequency
- Voltage fold-back constant current limit
- Latched output over-voltage protection
- Non-latching output over-current protection
- Non-latching over-temperature protection

- Auto-recovery input under and over voltage protections
- UL 60950 (US and Canada), VDE 0805, CB scheme (IEC950)
- CE Mark (EN60950)
- EMI: CISPR 22 A or B with external filter
- US 6,618,274. Other patents pending
- ISO Certified manufacturing facilities

Optional Features:

- Negative remote on/off logic
- Short Thru-hole pins 2.79 mm (0.110")
- Long Thru-hole pins 4.57 mm (0.180")
- Long Thru-hole pins 5.08 mm (0.200")
- Thru-hole mounting studs
- Non-latching output OVP protection
- Latched over-current protection
- Latched over-temperature protection



Data Sheet: Supereta™ iQN Series –Single Output Quarter Brick

Ordering information:

Product Identifier	Package Size	Platform	Input Voltage	Output Current/Power	Output Units	Main Output Voltage	# of Outputs	Safety Class	Feature Set
i	Q	N	48	007	A	280	V	- 0	00
TDK Innoveta	Quarter-brick	Supereta	36-75V	007 – 7 A	Amps	280 – 28V	Single		00 – Standard

Option Table:

Feature Set	On/Off Logic	OVP	Pin Length
00	Positive	Latch	0.145"
01	Negative	Latch	0.145"
02	Positive	Latch	0.110"
03	Negative	Latch	0.110"
04	Positive	Latch	0.200"
05	Negative	Latch	0.200"
06	Positive	Non-Latch	0.145"
07	Negative	Non-Latch	0.145"
08	Positive	Latch	0.180"
09	Negative	Latch	0.180"

Product Offering:

Code	Input Voltage	Output Voltage	Output Current	Maximum Output Power	Efficiency
iQN48007A280V	36-75V	28V	7A	196W	92%

TDK Innoveta Inc.

3320 Matrix Drive, Suite 100
Richardson, Texas 75082

Phone (877) 498-0099 Toll Free
(469) 916-4747

Fax (877) 498-0143 Toll Free
(214) 239-3101

support@tdkinnoveta.com
<http://www.tdkinnoveta.com/>

Mechanical Specification:

Dimensions are in mm [in]. Unless otherwise specified tolerances are: $x.x \pm 0.5$ [0.02], $x.xx$ and $x.xxx \pm 0.25$ [0.010].

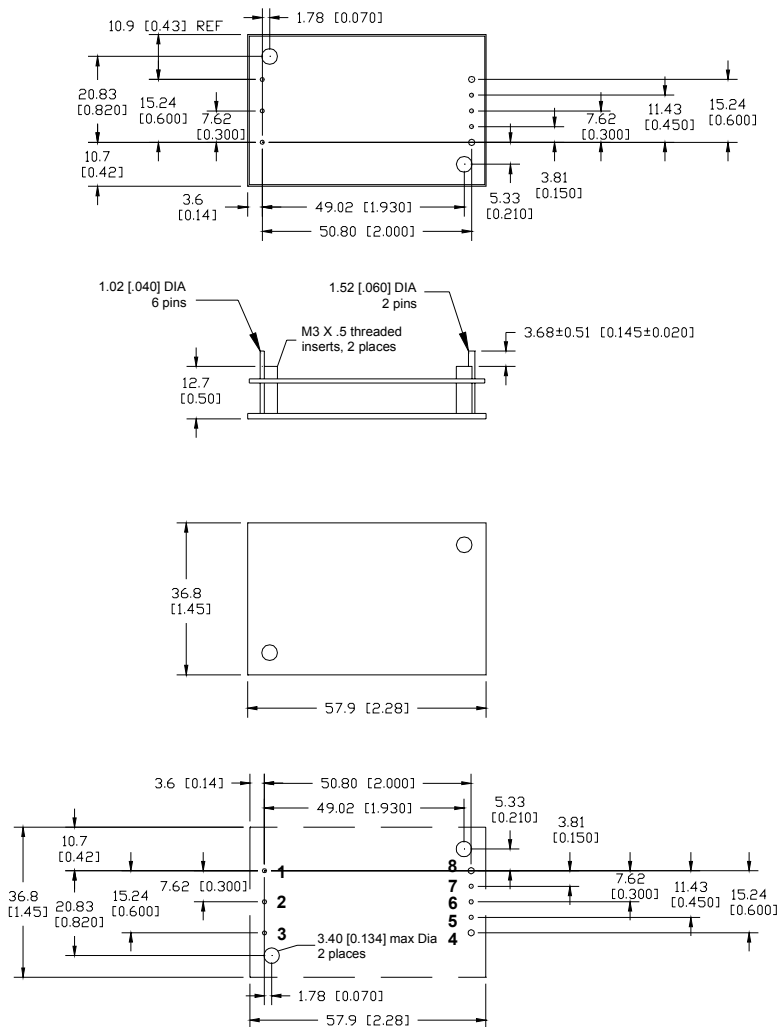

Recommended hole pattern (top view)

Pin Assignment:

PIN	FUNCTION	PIN	FUNCTION
1	Vin(+)	4	Vo(-)
2	On/Off	5	Sense(-)
3	Vin(-)	6	Trim
		7	Sense(+)
		8	Vo(+)

Pin base material is copper or brass with matte tin or tin/lead plating; the maximum module weight is 60g (2.1 oz).

Data Sheet: Supereta™ iQN Series –Single Output Quarter Brick

Absolute Maximum Ratings:

Stress in excess of Absolute Maximum Ratings may cause permanent damage to the device.

Characteristic	Min	Max	Unit	Notes & Conditions
Continuous Input Voltage	-0.5	80	Vdc	
Transient Input Voltage	---	100	Vdc	100mS max.
Isolation Voltage				
Input to Output	---	1500	Vdc	Basic Insulation
Input to Base-plate	---	1500	Vdc	Basic Insulation
Output to Base-plate	---	500	Vdc	Operational Insulation
Storage Temperature	-55	125	°C	
Operating Temperature Range (Tc)	-40	115	°C	Measured at the location specified in the thermal measurement figure. Maximum temperature varies with model number, output current, and module orientation – see curve in thermal performance section of the data sheet.

Input Characteristics:

Unless otherwise specified, specifications apply over all Rated Input Voltage, Resistive Load, and Temperature conditions.

Characteristic	Min	Typ	Max	Unit	Notes & Conditions
Operating Input Voltage	36	48	75	Vdc	
Maximum Input Current					
7A output	---	---	7	A	Vin = 0 to Vin,max
Turn-on Voltage	---	34.5	---	Vdc	
Turn-off Voltage	---	32.3	---	Vdc	
Hysteresis	---	2.2	---	Vdc	
Startup Delay Time from application of input voltage	---	10	---	mS	Vo = 0 to 0.1*Vo,nom; on/off =on, Io=Io,max, Tc=25°C
Startup Delay Time from on/off	---	10	---	mS	Vo = 0 to 0.1*Vo,nom; Vin = Vi,nom, Io=Io,max,Tc=25°C
Output Voltage Rise Time	---	48	---	mS	Io=Io,max,Tc=25°C, Vo=0.1 to 0.9*Vo,nom
Inrush Transient	---	---	0.2	A ² s	Exclude external input capacitors
Input Reflected Ripple	---	---	---	mApp	See input/output ripple and noise measurements figure; BW = 20 MHz
Input Ripple Rejection	---	35	---	dB	@120Hz

* Engineering Estimate

** Consult TDK Innoveta for slow start-up with heavy capacitive load

Caution: The power modules are not internally fused. An external input line normal blow fuse with a maximum value of 15A is required; see the Safety Considerations section of the data sheet.

Data Sheet: Supereta™ iQN Series –Single Output Quarter Brick

Electrical Data:

iQN48007A280V-000 through -009: 28V, 7A Output

Characteristic	Min	Typ	Max	Unit	Notes & Conditions
Output Open Circuit Voltage Set-point	27.72	28	28.28	Vdc	Vin=Vin,min to Vin,max, Io=0A, Tc = 25°C
Output Voltage Initial Set-point Tolerance	27.44	28	28.56	Vdc	Over all rated input voltage and temperature conditions with Io=0A to end of life
Efficiency	---	92	---	%	Vin=Vin,nom; Io=Io,max; Tc = 25°C
Line Regulation	---	28	56*	mV	Vin=Vin,min to Vin,max, Io and Tc fixed
Droop Rate	---	125	---	mV/A	Vin=Vin,min to Vin,max, Tc = 25°C
Temperature Regulation	---	125	300*	mV	Tc=Tc,min to Tc,max, Vin and Io fixed
Load Share Accuracy	---	5	---	%	60% to 100% load current, Tc = 25°C
Output Current	0	---	7	A	At loads less than Io,min the module will continue to regulate the output voltage, but the output ripple may increase slightly
Output Current Limiting Threshold	---	8.2	---	A	Vo = 0.9*Vo,nom, Tc<Tc,max
Short Circuit Current	0	0	---	A	Latch off
Output Ripple and Noise Voltage	---	75	200	mVpp	Vin=48V, Io≥Io,min, Tc=25°C. Measured across one 0.1uF, one 1.0 uF, one 40uF ceramic, and two 220uF low esr aluminum electrolytic capacitors located 2 inches away – see input/output ripple measurement figure; BW = 20MHz
	---	19	40	mVrms	
Output Voltage Adjustment Range	17	---	30.8**	V	Note: Trim up 10% is possible, but the load current needs to be reduced
Output Voltage Remote Sense Range	---	---	10	%Vo,nom	
Dynamic Response:					di/dt = 0.1A/uS, Vin=Vin,nom; load step from 50% to 75% of Io,max, Tc=25°C with at least one 1.0 uF, one 47uF ceramic, and a 68uF low esr aluminum electrolytic capacitors across the output terminals.
Recovery Time to 10% of Peak Deviation	---	850	---	μS	
Transient Voltage	---	375	---	mV	Note: Exclude the droop.
Output Voltage Overshoot during Startup	0	0	---	mV	Vin=Vin,nom; Io=Io,max, Tc=25°C
Switching Frequency	---	155	---	kHz	Fixed
Output Over Voltage Protection	32.8	33.6	35	V	
External Load Capacitance	68	---	4,000 †	uF	Minimum ESR > 2.5 mΩ. Tc=25°C
Isolation Capacitance	---	1000	---	pF	
Isolation Resistance	10	---	---	MΩ	
Vref		2.5		V	Required for trim calculation

* Engineering Estimate

** When trim up, the load current needs to be reduced. Contact TDK Innoveta for details

† Contact TDK Innoveta for applications that require additional capacitance or using capacitors with very low ESR

Electrical Characteristics:

iQN48007A280V-000 through -009: 28V, 7A Output

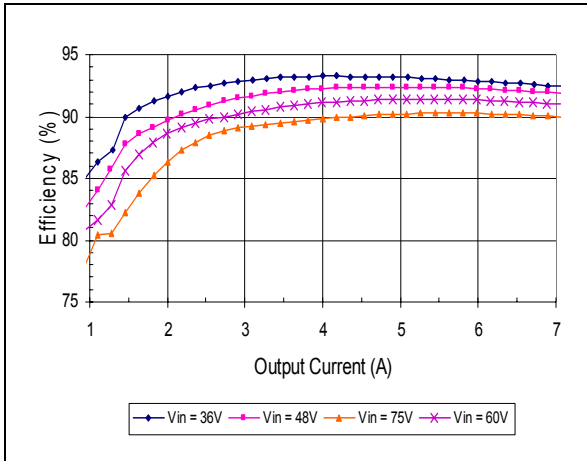

Efficiency vs. Vin at Ta=25°C, No Heat Sink

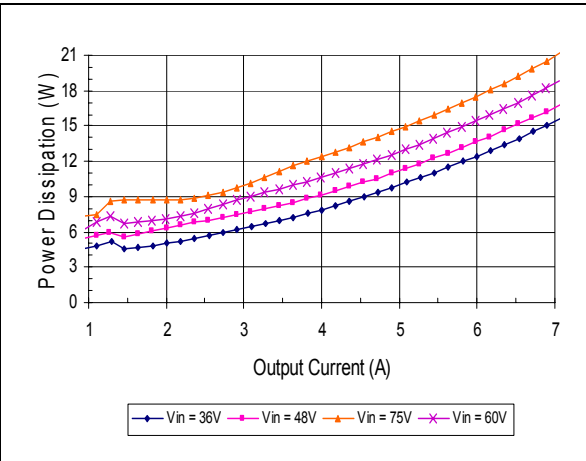

Power Dissipation vs. Vin at Ta=25°C, No Heat Sink

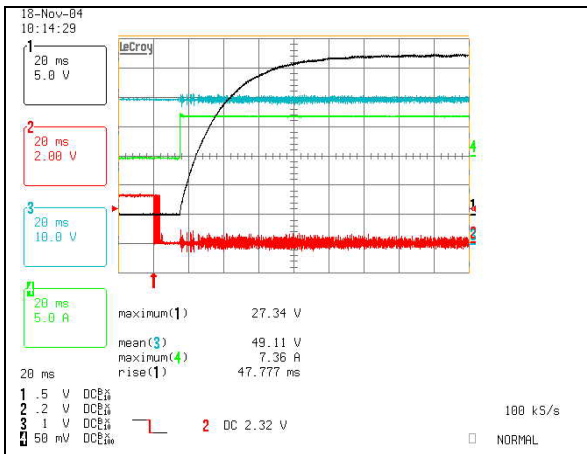

Start-up constant current load from on/off switch, 48V Vin
Ch. 1: Vo Ch. 2: on/off Ch. 3: Vin Ch. 4: Io

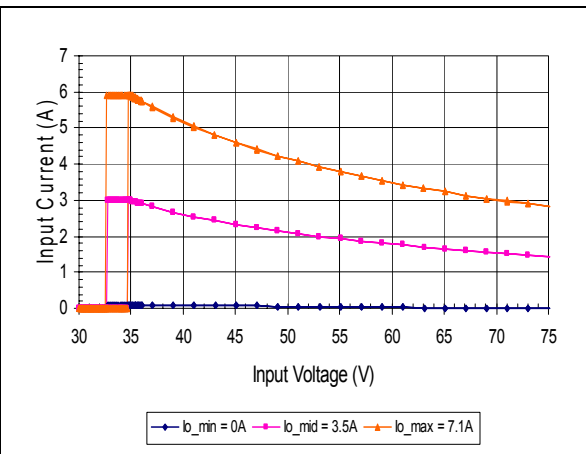

Typical Input Current vs. Vin Characteristics

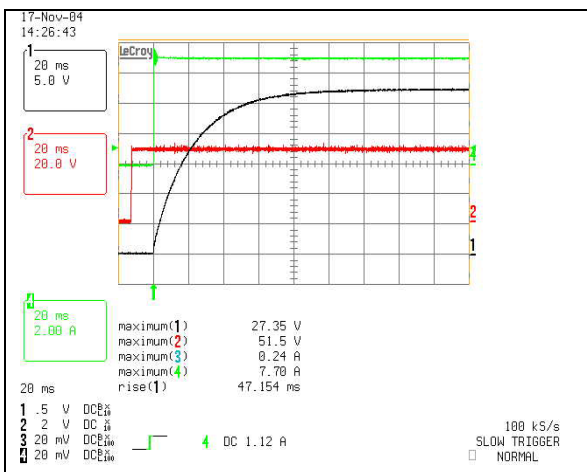

Start-up constant current load from Vin Application
Ch. 1: Vo Ch. 2: Vin Ch. 4: Io

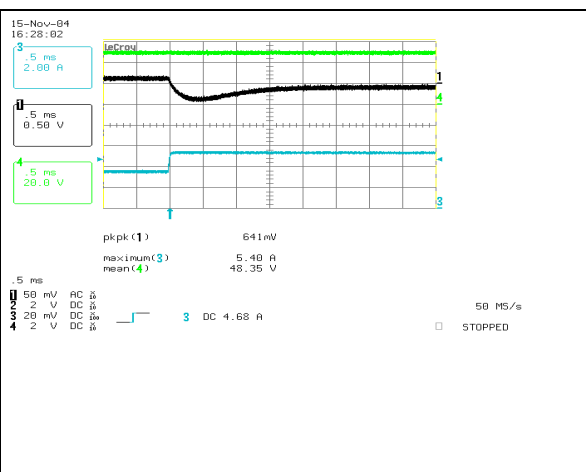

Transient Response. Load Step from 50% to 75% of Full Load with di/dt= 0.1A/uS. Ch. 1: Vo Ch. 3: Io

Electrical Characteristics (continued): iQN48007A280V-000 through -009: 28V, 7A Output

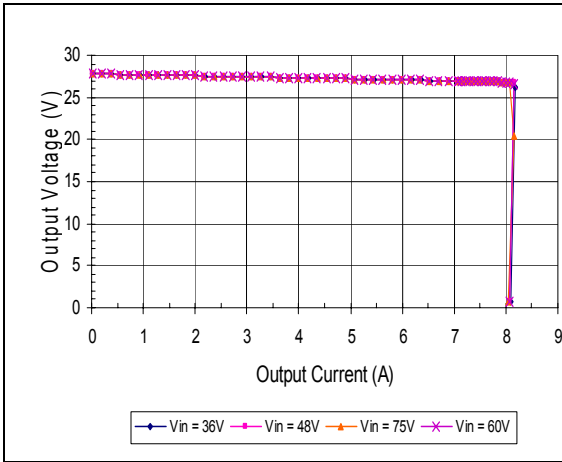

Output Current Limit Characteristics vs. Vin at Ta=25C.

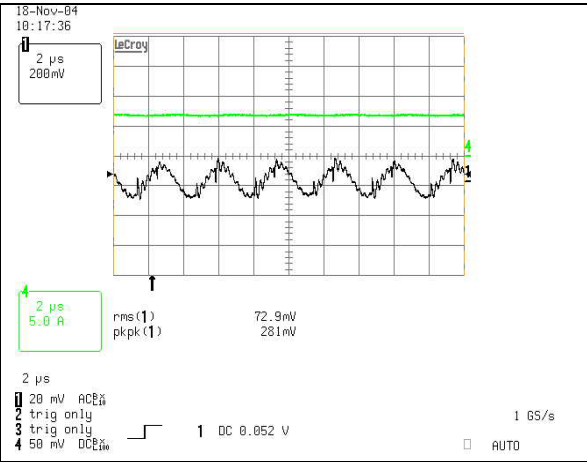

Typical Output Ripple at 48V Input and Full Load. Cext=440uF. Ch. 1: Vo Ch. 4: Io

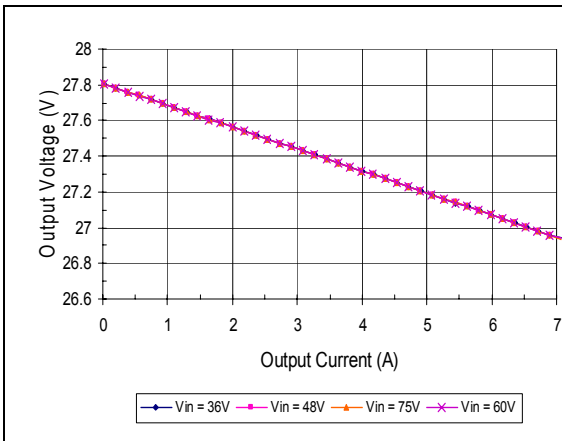

Typical Output Voltage vs. Load Current at Ta=25C.

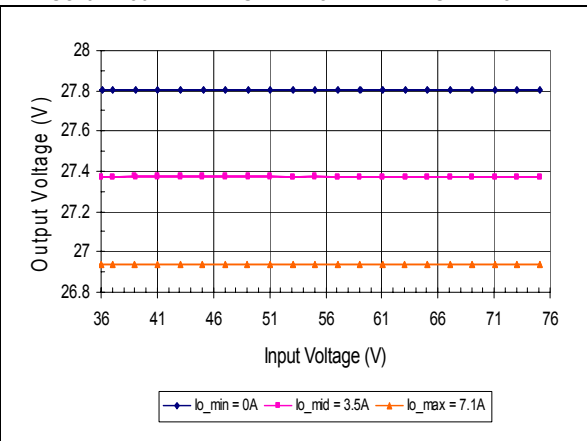

Typical Output Voltage vs. Vin at Ta=25C.

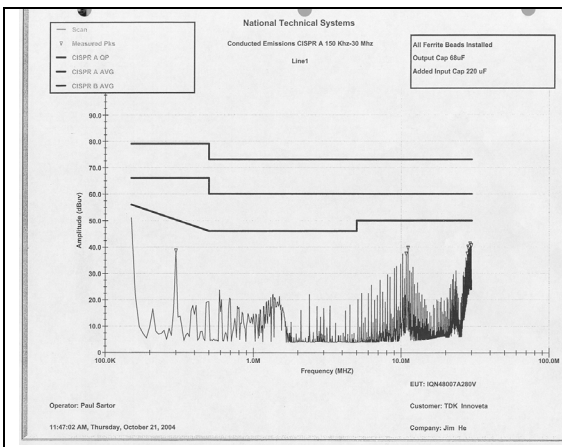

Conducted Emission with CISPR Class B

% Change of Vout	Trim Down Resistor (Ohm)	% Change of Vout	Trim Up Resistor (Ohm)
-10	52.7K	+5	1313K
-20	21.8K	+10	691.5K

e.g. trim down 30%

$$R_{down} := 6.19 \left(\frac{100}{30} - 1 \right) - 3.01 \quad K$$

Calculated Resistor Values for Output Voltage Adjustment

Data Sheet: Supereta™ iQN Series –Single Output Quarter Brick

Thermal Performance: iQN48007A280V-000 through -009: 28V, 7A Output

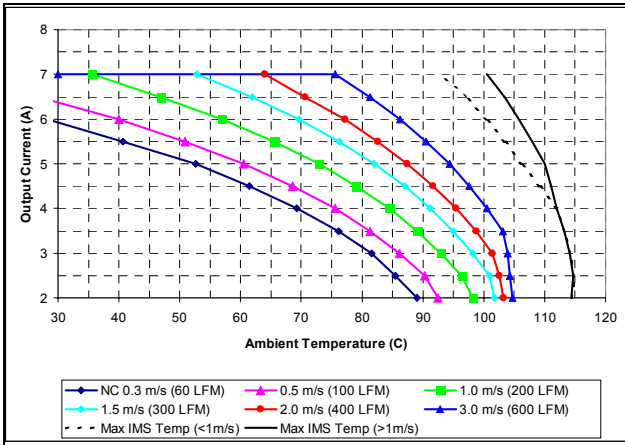

Maximum output current vs. ambient temperature at nominal input voltage for airflow rates of 0.3m/s to 3.0m/s with airflow from pin 3 to pin 1 (best orientation).

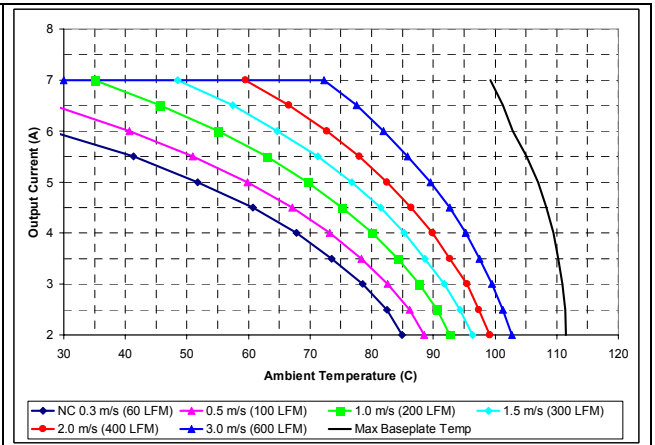

Maximum output current vs. ambient temperature at nominal input voltage for airflow rates of 0.3m/s to 3.0m/s with airflow from pin 1 to pin 8.

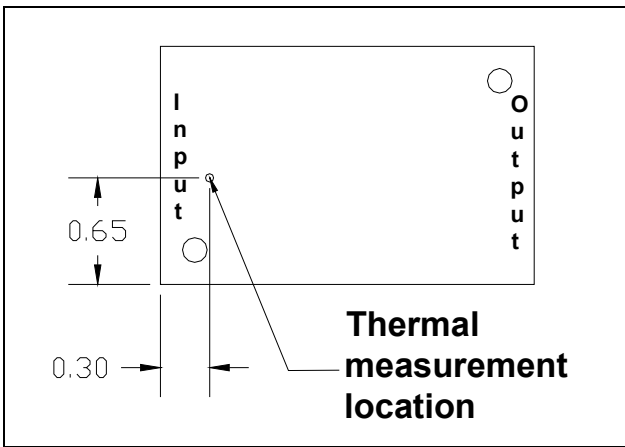

Thermal measurement location on baseplate – top view

The thermal curves provided are based upon measurements made in TDK Innoveta's experimental test setup that is described in the Thermal Management section. Due to the large number of variables in system design, TDK Innoveta recommends that the user verify the module's thermal performance in the end application. The critical component should be thermo- coupled and monitored, and should not exceed the temperature limit specified in the derating curve above. It is critical that the thermocouple be mounted in a manner that gives direct thermal contact otherwise significant measurement errors may result.

Thermal Management:

An important part of the overall system design process is thermal management; thermal design must be considered at all levels to ensure good reliability and lifetime of the final system. Superior thermal design and the ability to operate in severe application environments are key elements of a robust, reliable power module.

A finite amount of heat must be dissipated from the power module to the surrounding environment. This heat is transferred by the three modes of heat transfer: convection, conduction and radiation. While all three modes of heat transfer are present in every application, convection is the dominant mode of heat transfer in most applications. However, to ensure adequate cooling and proper operation, all three modes should be considered in a final system configuration.

The open frame design of the power module provides an air path to individual components. This air path improves convection cooling to the surrounding environment, which reduces areas of heat concentration and resulting hot spots.

Test Setup: The thermal performance data of the power module is based upon measurements obtained from a wind tunnel test with the setup shown in the wind tunnel figure. This thermal test setup replicates the typical thermal environments encountered in most modern electronic systems with distributed power architectures. The electronic equipment in networking, telecom, wireless, and advanced computer systems operates in similar environments and utilizes vertically mounted printed circuit boards (PCBs) or circuit cards in cabinet racks.

The power module is mounted on a 0.062 inch thick, 6 layer, 2oz/layer PCB and is vertically oriented within the wind tunnel. Power is routed on the internal layers of the PCB. The outer copper layers are thermally decoupled from the converter to better simulate the customer's application. This also results in a more conservative derating. The cross section of the airflow passage is

rectangular with the spacing between the top of the module and a parallel facing PCB kept at a constant (0.5 in). The power module's orientation with respect to the airflow direction can have a significant impact on the unit's thermal performance.

Thermal Derating: For proper application of the power module in a given thermal environment, output current derating curves are provided as a design guideline in the

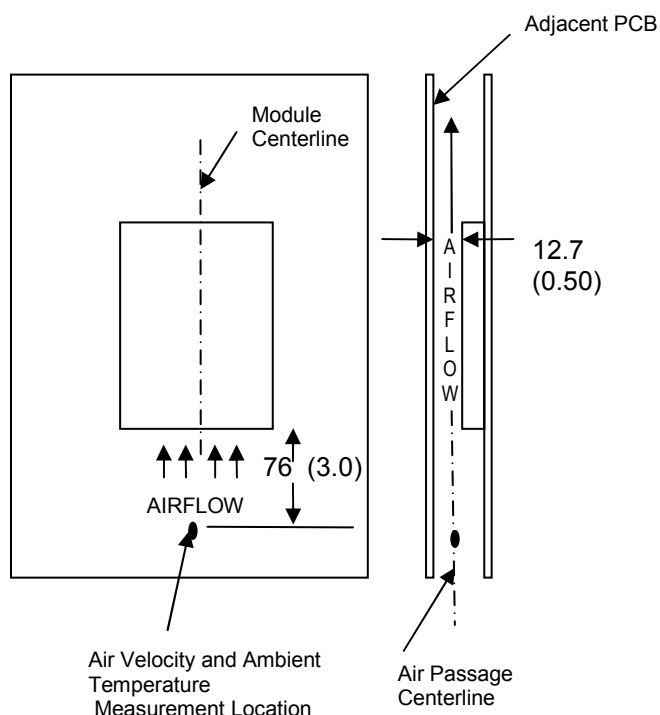

Wind Tunnel Test Setup Figure

Dimensions are in millimeters and (inches).

Thermal Performance section for the power module of interest. The module temperature should be measured in the final system configuration to ensure proper thermal management of the power module. For thermal performance verification, the module temperature should be measured at the component indicated in the thermal measurement location figure on the thermal

Data Sheet: Supereta™ iQN Series –Single Output Quarter Brick

performance page for the power module of interest. In all conditions, the power module should be operated below the maximum operating temperature shown on the derating curve. For improved design margins and enhanced system reliability, the power module may be operated at temperatures below the maximum rated operating temperature.

Heat transfer by convection can be enhanced by increasing the airflow rate that the power module experiences. The maximum output current of the power module is a function of ambient temperature (T_{AMB}) and airflow rate as shown in the thermal performance figures on the thermal performance page for the power module of interest. The curves in the figures are shown for 1m/s (200 ft/min) to 3 m/s (600 ft/min). In the final system configurations, the airflow rate for the natural convection condition can vary due to temperature gradients from other heat dissipating components.

Heatsink Usage: For applications with demanding environmental requirements, such as higher ambient temperatures or higher power dissipation, the thermal performance of the power module can be improved by attaching a heatsink or cold plate. The iQN platform is designed with a base plate with two M3 X 0.5 through-threaded mounting fillings for attaching a Heatsink or cold plate. The addition of a heatsink can reduce the airflow requirement; ensure consistent operation and extended reliability of the system. With improved thermal performance, more power can be delivered at a given environmental condition.

Standard heatsink kits are available from TDK Innoveta Inc for vertical module mounting in two different orientations

(longitudinal – perpendicular to the direction of the pins and transverse – parallel to the direction of the pins). The heatsink kit contains four M3 x 0.5 steel mounting screws and a precut thermal interface pad for improved thermal resistance between the power module and the heatsink. The screws should be installed using a torque-limiting driver set between 0.35-0.55 Nm (3-5 in-lbs).

The system designer must use an accurate estimate or actual measure of the internal airflow rate and temperature when doing the heatsink thermal analysis. For each application, a review of the heatsink fin orientation should be completed to verify proper fin alignment with airflow direction to maximize the heatsink effectiveness. For TDK Innoveta standard heatsinks, contact TDK Innoveta Inc. for latest performance data.

Operating Information:

Over-Current Protection: The power modules have current limit protection to protect the module during output overload and short circuit conditions. During overload conditions, the power modules may protect themselves by entering a constant current limit mode with output voltage foldback. Should the current tailed out during the short circuit condition; the second level non-latching 1-second hiccup mode over-current protection will be tripped.

The iQN Supereta series also offers an optional feature to latch the power module off. To remove the module from the latched condition, either cycle the input power or toggle the remote ON/OFF pin providing that over-current conditions have been removed. The reset time of the ON/OFF pin should be 500ms or longer. Consult the TDK Innoveta technical support for details.

Output Over-Voltage Protection: The power modules have a separate reference and control circuit, independent of the main control loop that reduces the risk of over voltage appearing at the output of the power module during a fault condition. If there is a fault in the main regulation loop, the over voltage protection circuitry will latch the power module off once it detects the output voltage condition as specified on the Electrical Data page. To remove the module from the latched condition, either cycle the input power or toggle the remote ON/OFF pin providing that over-voltage conditions have been removed. The reset time of the ON/OFF pin should be 500ms or longer.

The iQN series also offers an optional feature to allow non-latching 1-second hiccup mode over-voltage protection. Consult the TDK Innoveta technical support for details.

Thermal Protection: When the power modules exceed the maximum operating temperature, the modules will turn-off to

safeguard the units against thermal damage. The module will be turned off and auto-restarted after it is cooled down to allow non-latching over-temperature protection.

The iQN Supereta series also offers an optional feature to latch off the over-temperature fault. To reset the module from the latched condition, either cycle the input power or toggle the remote ON/OFF pin providing that the over-temperature conditions have been removed. Consult the TDK Innoveta technical support for details.

Remote On/Off: - The power modules have an internal remote on/off circuit. The user must supply an open-collector or compatible switch between the Vin(-) pin and the on/off pin. The maximum voltage generated by the power module at the on/off terminal is 15V. The maximum allowable leakage current of the switch is 50uA. The switch must be capable of maintaining a low signal Von/off < 1.2V while sinking 1mA.

The standard on/off logic is positive logic. The power module will turn on if pin 2 is left open and will be off if pin 2 is connected to pin 3. If the positive logic circuit is not being used, terminal 2 should be left open.

An optional negative logic is available. The module will turn on if pin 2 is connected to pin 3, and it will be off if pin 2 is left open. If the negative logic feature is not being used, pin 2 should be shorted to pin 3.

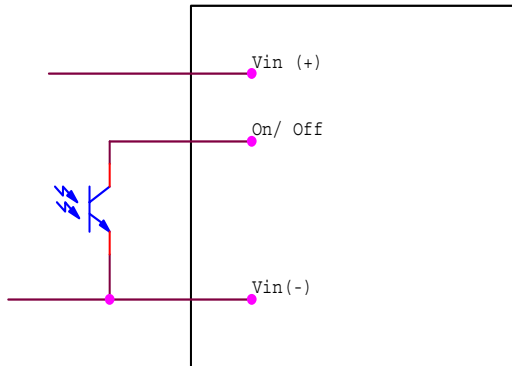

On/Off Circuit for positive or negative logic

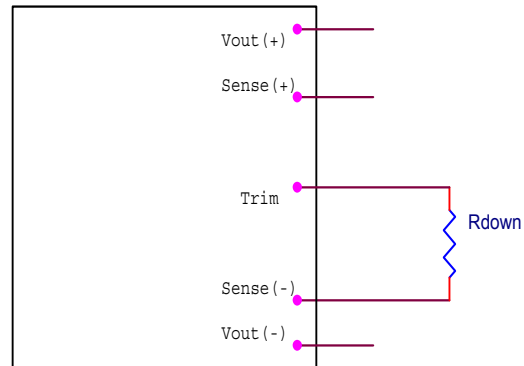

Circuit to decrease output voltage

Output Voltage Adjustment: The output voltage of the module may be adjusted by using an external resistor connected between the trim pin 6 and either the Sense (+) or Sense (-) pin. If the voltage trim feature is not used, pin 6 should be left open. Care should be taken to avoid injecting noise into the module’s trim pin. A small 0.01uF capacitor between the power module’s trim pin and Sense (-) pin may help to avoid this.

With a resistor between the trim pin and Sense (-) pin, the output voltage is adjusted down. To adjust the output voltage down a percentage of Vout ($\Delta\%$) from $V_{o,nom}$, the trim resistor should be chosen according to the following equation:

$$R_{down} = 6.19 \times \left(\frac{100}{\Delta\%} - 1 \right) - 3.01 \quad (\text{k}\Omega)$$

Where

$$\Delta\% = 100 \times (V_{o,nom} - V_{desired}) / V_{o,nom}$$

The current limit set point does not increase as the module is trimmed down, so the available output power is reduced.

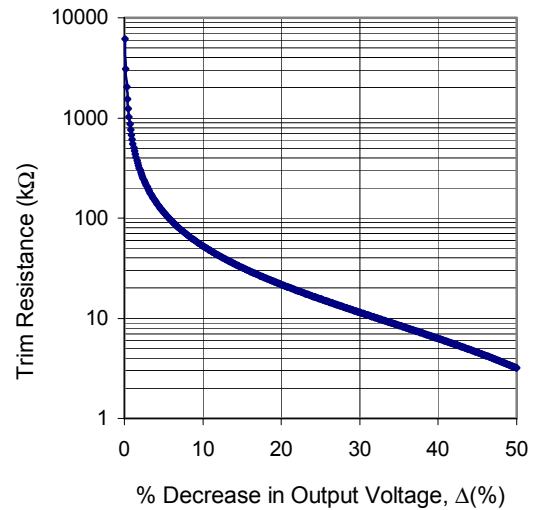

With a resistor between the trim pin and sense (+) pin, the output voltage is adjusted up. To adjust the output voltage up a percentage of Vout ($\Delta\%$) from $V_{o,nom}$ the trim resistor (in k Ω) should be chosen according to the following equation:

$$R_{up} = 6.19 \times \left(\frac{V_{o,nom} \times (100 + \Delta\%)}{V_{ref} \times \Delta\%} - \frac{100}{\Delta\%} \right) - 9.2$$

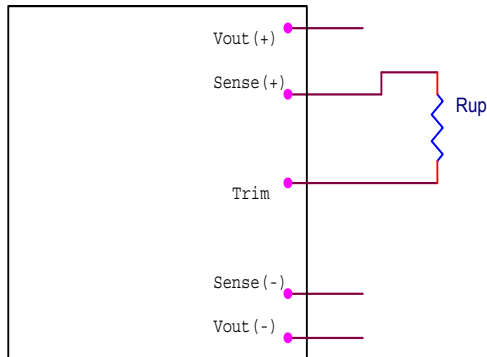

Circuit to increase output voltage

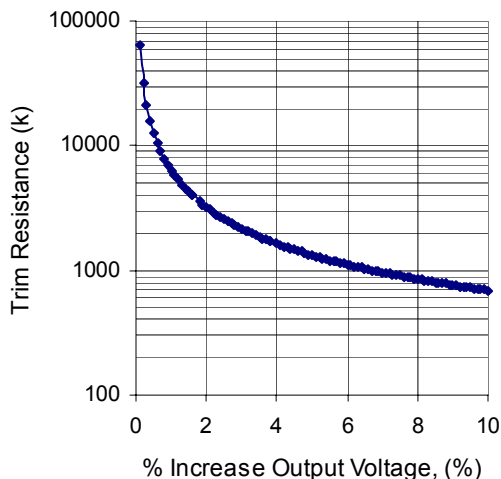

The value of V_{ref} can be found in the Electrical Data section of this data sheet. The maximum power available from the power module is fixed. As the output voltage is trimmed up, the maximum output current must be decreased to maintain the maximum rated power of the module. It is also desirable to slightly increase the input voltage while trimming up the output with heavy load current.

As the output voltage is trimmed up, the output over-voltage protection set point is not adjusted. Trimming the output voltage too high may cause the output over voltage protection circuit to be triggered.

Remote Sense: The power modules feature remote sense to compensate for the effect of output distribution drops. The output voltage sense range defines the maximum voltage allowed between the output power terminals and output sense terminals, and it is found on the electrical data page for the power module of interest. If the remote sense feature is not being used, the Sense(+) pin should be connected to the Vo(+) pin and the Sense (-) pin should be connected to the Vo(-) pin.

The output voltage at the Vo(+) and Vo(-) terminals can be increased by either the remote sense or the output voltage adjustment feature. The maximum voltage increase allowed is the larger of the remote sense range or the output voltage adjustment range; it is not the sum of both.

As the output voltage increases due to the use of the remote sense, the maximum load current must be decreased for the module to remain below its maximum power rating.

EMC Considerations: TDK Innoveta power modules are designed for use in a wide variety of systems and applications. With the help of external EMI filters and careful layout, it is possible to meet CISPR 22 class A or B requirement. For assistance with designing for EMC compliance, please contact TDK Innoveta technical support.

Input Impedance: The source impedance of the power feeding the DC/DC converter module will interact with the DC/DC converter. To minimize the interaction, one or more 100uF - 220uF/100V input electrolytic capacitors should be present if the source inductance is greater than 4uH.

Reliability:

The power modules are designed using TDK Innoveta’s stringent design guidelines for component derating, product qualification, and design reviews. Early failures are screened out by both burn-in and an automated final test. The MTBF is calculated to be greater than 2.3M hours at

Data Sheet: Supereta™ iQN Series –Single Output Quarter Brick

nominal input, full load, and $T_a = 40^\circ\text{C}$ using the Telcordia TR-332 issue 6 calculation method.

Improper handling or cleaning processes can adversely affect the appearance, testability, and reliability of the power modules. Contact TDK Innoveta technical support for guidance regarding proper handling, cleaning, and soldering of TDK Innoveta's power modules.

Quality:

TDK Innoveta's product development process incorporates advanced quality planning tools such as FMEA and CpK analysis to ensure designs are robust and reliable. All products are assembled at ISO certified assembly plants.

Input/Output Ripple and Noise Measurements:

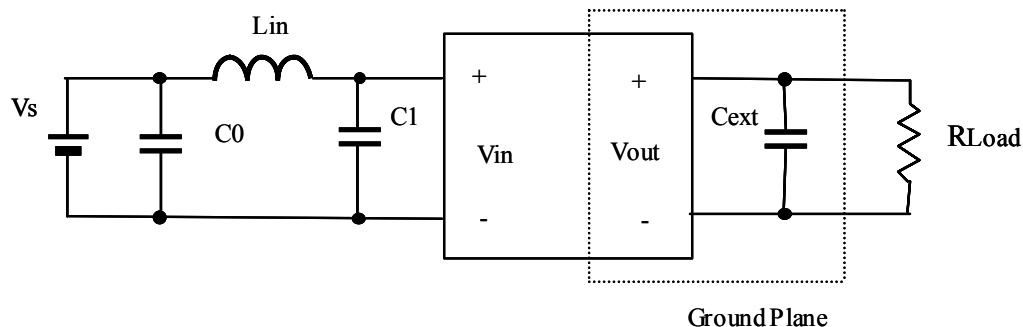

The input reflected ripple is measured with a current probe and oscilloscope. The ripple current is the current through a $12\mu\text{H}$ differential mode inductor, L_{in} , with $esr \leq 10\text{ m}\Omega$, feeding a capacitor, C_1 , $esr \leq 700\text{ m}\Omega @ 100\text{kHz}$, across the module input voltage pins. The capacitor C_1 across the input shall be at least $100\mu\text{F}/100\text{V}$. A $220\mu\text{F}/100\text{V}$ capacitor is recommended. A $220\mu\text{F}/100\text{V}$ capacitor for C_0 is also recommended.

The output ripple measurement is made approximately 7 cm (2.75 in.) from the power module using an oscilloscope and BNC socket. The capacitor C_{ext} is located about 5 cm (2 in.) from the power module; its value varies from code to code and is found on the electrical data page for the power module of interest under the ripple & noise voltage specification in the Notes & Conditions column.



Data Sheet: Supereta™ iQN Series –Single Output Quarter Brick

Safety Considerations:

For safety agency approval of the system in which the DC-DC power module is installed, the power module must be installed in compliance with the creepage and clearance requirements of the safety agency. The isolation is basic insulation. For applications requiring basic insulation, care must be taken to maintain minimum creepage and clearance distances when routing traces near the power module.

As part of the production process, the power modules are hi-pot tested from primary and secondary at a test voltage of 1500Vdc.

To preserve maximum flexibility, the power modules are not internally fused. An external input line normal blow fuse with a maximum value of 15A is required by safety agencies. A lower value fuse can be selected based upon the maximum dc input current and maximum inrush energy of the power module.

When the supply to the DC-DC converter is less than 60Vdc, the power module meets all of the requirements for SELV. If the input voltage is a hazardous voltage that exceeds 60Vdc, the output can be considered SELV only if the following conditions are met:

- 1) The input source is isolated from the ac mains by reinforced insulation.
- 2) The input terminal pins are not accessible.
- 3) One pole of the input and one pole of the output are grounded or both are kept floating.
- 4) Single fault testing is performed on the end system to ensure that under a single fault, hazardous voltages do not appear at the module output.

Warranty:

TDK Innoveta's comprehensive line of power solutions includes efficient, high-density DC-DC converters. TDK Innoveta offers a three-year limited warranty. Complete warranty information is listed on our web site or is available upon request from TDK Innoveta.

TDK Innoveta Inc.

3320 Matrix Drive, Suite 100
Richardson, Texas 75082

Phone (877) 498-0099 Toll Free
(469) 916-4747

Fax (877) 498-0143 Toll Free
(214) 239-3101

support@tdkinnoveta.com
<http://www.tdkinnoveta.com/>

Information furnished by TDK Innoveta is believed to be accurate and reliable. However, TDK Innoveta assumes no responsibility for its use, nor for any infringement of patents or other rights of third parties, which may result from its use. No license is granted by implication or otherwise under any patent or patent rights of TDK Innoveta. TDK Innoveta components are not designed to be used in applications, such as life support systems, wherein failure or malfunction could result in injury or death. All sales are subject to TDK Innoveta's Terms and Conditions of Sale, which are available upon request. Specifications are subject to change