

**Dualeta™ iQA Series DC/DC Power Modules**  
 48V Input, 15A Output  
 Dual Output Quarter Brick



The Dualeta™ Family is a **75W** family of highly versatile, **independently regulated, dual output quarter brick** power modules with output voltage tracking. Its output current loading scheme is fully flexible: **0 to 15A** can be drawn from either output with no minimum load requirements. An **ultra wide range independent output trim** allows the realization of dual output voltage combinations between 1.5 and 5.5V. The superior versatility of the Dualeta™ family substantially reduces the quantity of distinct part numbers in the end user part portfolio, lowering cost of ownership.

**Features**

- **Standard Dual Quarter Brick format**
- **A single module which can support all your dual voltage requirements between 1.5V and 5.5V**
- **Two output trim options:**
  - **Standard Dual Trim** – wide range independent adjustment of either output, using two trim pins
  - **Optional Single Tracking Trim** – adjust both outputs together by 10% according to industry standard resistor tables
- **Independently regulated, tight tolerance outputs**
- **Flexible loading: 0-15A from either output, 15A total load**
- **High efficiency – up to 89%**
- **Industry-leading output power: 75W**
- **Basic insulation – 1500 Vdc**
- Full, auto-recovery protection:
  - Input under and over voltage
  - Output over voltage
  - Current limit
  - Short circuit
  - Thermal limit

- Monotonic, tracking start-up
- Starts with pre-biased outputs
- High reliability open frame, surface mount construction
- Baseplate for improved thermal management
- UL 60950 (US and Canada), VDE 0805, CB scheme (IEC950)
- Patented Technology

**Options**

- Optional Single Tracking Trim – using industry standard resistor tables
- Remote on/off (negative logic)
- Short Thru-hole pins 2.79 mm (0.110")



## Advance Data Sheet: Dualeta™ iQA Series – Dual Quarter Brick

### Ordering information

Product Identifier	Package Size	Platform	Input Voltage	Output Current/Power	Output Units	Main Output Voltage	# of Outputs	Safety Class	Feature Set
i	Q	A	48	015	A	050	M	- 0	00
TDK Innoveta	Quarter Brick	Dualeta™	36-75V	15	Amps	050 – 5.0V 033 – 3.3V	Multiple		00 – Standard

Feature Set	On/Off Logic	Pin Length	Trim
00	Positive	0.145"	Dual independent pins
01	Negative	0.145"	Dual independent pins
02	Positive	0.145"	Single tracking pin
03	Negative	0.145"	Single tracking pin
04	Positive	0.110"	Dual independent pins
05	Negative	0.110"	Dual independent pins
06	Positive	0.110"	Single tracking pin
07	Negative	0.110"	Single tracking pin

### Product Offering

Code	Input Voltage	Output Voltage	Output Current	Maximum Output Power	Efficiency
iQA48015A050M-000	36V to 75V	5.0/3.3V	15A	75W	87%
iQA48015A033M-000	36V to 75V	3.3/2.5V	15A	50W	85%



3320 Matrix Drive  
Suite 100  
Richardson, Texas 75082

Phone (877) 498-0099 Toll Free  
(469) 916-4747  
Fax (877) 498-0143 Toll Free  
(214) 239-3101

[support@tdkinnoveta.com](mailto:support@tdkinnoveta.com)  
<http://www.tdkinnoveta.com/>

## Mechanical Specification

Dimensions are in mm [in]. Unless otherwise specified tolerances are:  $x.x \pm 0.5$  [0.02],  $x.xx$  and  $x.xxx \pm 0.25$  [0.010].

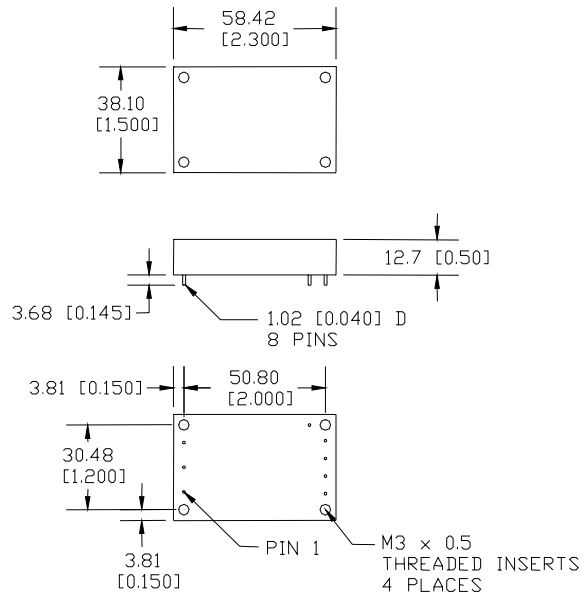

## Recommended Hole Pattern: (top view)

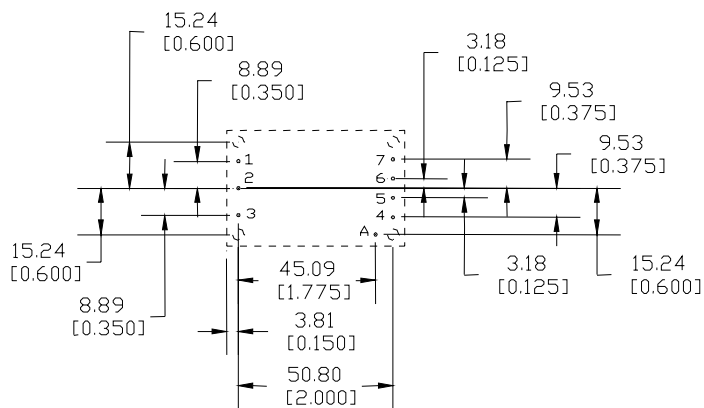

## Pin Assignment:

PIN	FUNCTION	PIN	FUNCTION
1	Vin (+)	5	Output RTN
2	On/Off (-)	6	Vo1 Trim (Optional: Single tracking trim pin)
3	Vin (-)	7	Vo1 (+)
4	Vo2 (+)	A	Vo2 Trim (Optional: Omit for single trim pin option)

## Absolute Maximum Ratings:

Stress in excess of Absolute Maximum Ratings may cause permanent damage to the device.

Characteristic	Min	Max	Unit	Notes & Conditions
Continuous Input Voltage	-0.5	80	Vdc	
Transient Input Voltage	---	100	Vdc	100mS max.
Isolation Voltage Input to Output Input to Baseplate Output to Baseplate	---	1500 1500 500	Vdc Vdc Vdc	Basic insulation Basic insulation Operational insulation
Storage Temperature	-55	125	°C	
Operating Temperature Range (Tc)	-40	105*	°C	Maximum baseplate temperature.

\* Engineering estimate.

## Input Characteristics:

Unless otherwise specified, specifications apply over all Rated Input Voltage, Resistive Load, and Temperature conditions.

Characteristic	Min	Typ	Max	Unit	Notes & Conditions
Operating Input Voltage	36	48	75	Vdc	
Maximum Input Current	---	---	3.0*	A	Vin = 0 to Vin,max
Turn-on Voltage	---	34	---	Vdc	
Turn-off Voltage	30*	32	---	Vdc	
Hysteresis	0.5*	2	---	Vdc	
Startup Delay Time from application of input voltage	---	12	---	mS	Vo = 0 to 0.1*Vo,nom; On/Off =on, Io=Io,max, Tc=25°C
Startup Delay Time from on/off	---	10	---	mS	Vo = 0 to 0.1*Vo,nom; Vin = Vi,nom, Io=Io,max, Tc=25°C
Output Voltage Rise Time	---	50	---	mS	Io=Io,max, Tc=25°C, Vo=0.1 to 0.9*Vo,nom
Inrush Transient	---	---	0.1	A²s	
Input Reflected Ripple	---	15	---	mApp	See input/output ripple measurement figure; BW = 5 MHz
Input Ripple Rejection	---	50*	---	dB	@120Hz

\*Engineering Estimate

Caution: The power modules are not internally fused. An external input line normal blow fuse with a maximum value of 10A is required; see the Safety Considerations section of the data sheet.

## Electrical Data:

### iQA48015A033M: 3.3V/2.5V, 15A Output

Characteristic	Min	Typ	Max	Unit	Notes & Conditions
Output Voltage Initial Setpoint Vout1 Vout2	3.25 2.46	3.3 2.5	3.35 2.54	Vdc Vdc	Vin=Vin,nom; Io=Io,max; Tc = 25°C
Output Voltage Tolerance Vout1 Vout2	3.20 2.42	3.3 2.5	3.40 2.58	Vdc Vdc	Over all rated input voltage, load, and temperature conditions to end of life
Efficiency	83*	85	---	%	Vin=Vin,nom; Io1=7.5A, Io2=7.5A; Tc = 25°C
Line Regulation	---	2	5*	mV	Vin=Vin,min to Vin,max
Load Regulation	---	5	15*	mV	Io=Io,min to Io,max
Temperature Regulation	---	10	75*	mV	Tc=Tc,min to Tc,max
Output Current	0	---	15	A	Sum of output currents, Io1+Io2
Output Current Limiting Threshold	---	19	---	A	Vo1 = 0.9*Vo,nom, Tc<Tc,max
Short Circuit Current	---	3	---	A	Vo = 0.25V, Tc = 25°C; average output current in current limit hiccup mode
Output Ripple and Noise Voltage Vout1 Vout2  Vout1 Vout2	--- ---  --- ---	30 25  10 10	80 70  --- ---	mVpp mvpp  mVrms mVrms	Measured with 47uF Tantalum and 1uF ceramic external capacitance – see input/output ripple measurement figure; BW = 20MHz
Output Voltage Adjustment Range Tracking trim option	90	---	110	%Vout,nom	%Vout,nom
Dynamic Response: Recovery Time	---	0.1	---	mS	di/dt = 0.1A/uS, Vin=Vin,nom; load step from 50% to 75% of Io,max, either output
Transient Voltage	---	80	---	mV	
Output Voltage Overshoot during startup Vout1 Vout2	--- ---	250 150	--- ---	mV mV	Io=Io,max, Tc=25°C
Switching Frequency	---	280	---	kHz	Fixed
Output Over Voltage Protection Tracking trim option Vo1 Vo2	3.7 2.9	--- ---	5.0* 4.0*	V V	
External Load Capacitance	0	---	5000*&	uF	
Isolation Capacitance	---	1000	---	pF	
Isolation Resistance	10	---	---	MΩ	

\*Engineering Estimate

& Contact Innoveta for applications that require additional capacitance or very low ESR capacitor banks.

## Electrical Characteristics:

### iQA48015A033M: 3.3V/2.5V, 15A Output

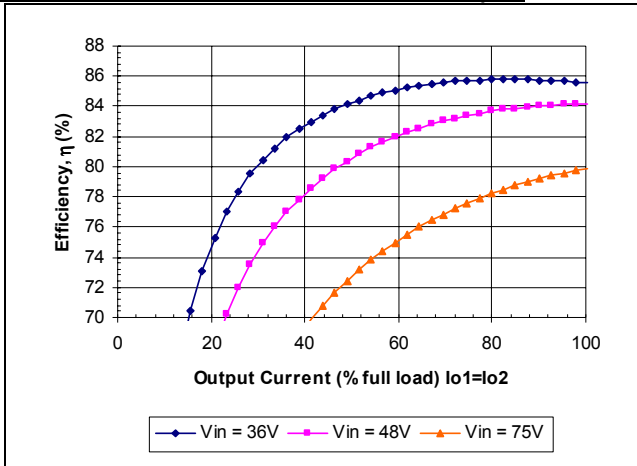

Typical Efficiency vs. Input Voltage at Ta=25°C.

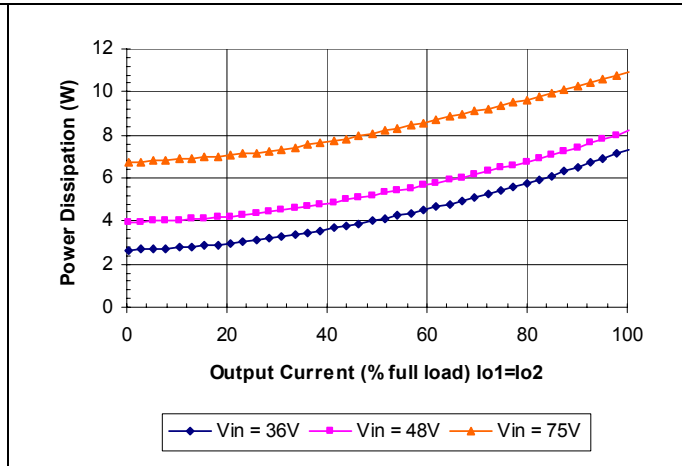

Typical Power Dissipation vs. Input Voltage at Ta=25°C.

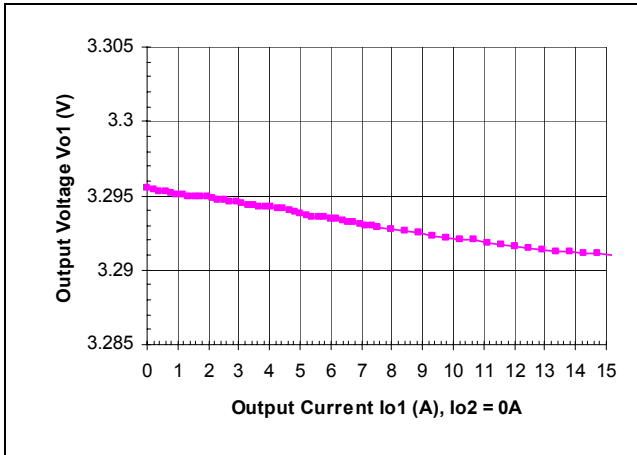

Typical Output 1 Voltage vs. Load Current at Ta = 25°C.

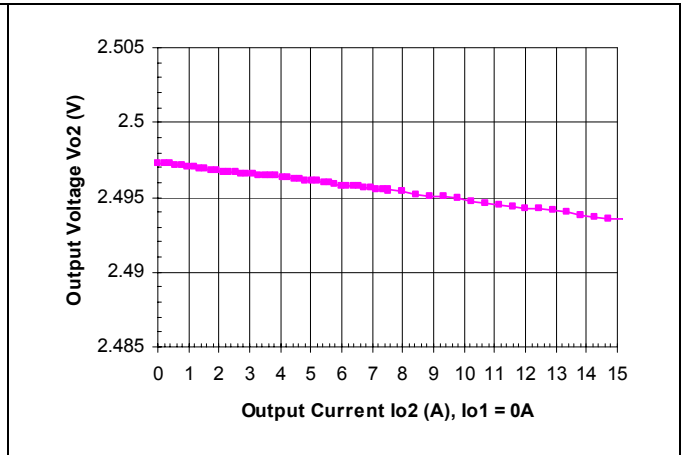

Typical Output 2 Voltage vs. Load Current at Ta = 25°C.

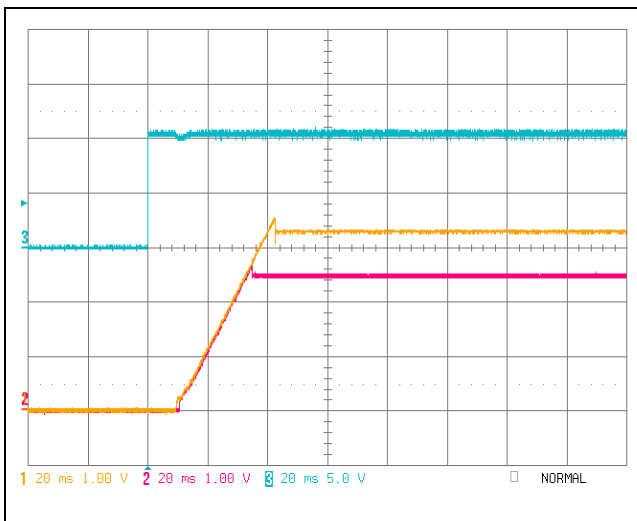

Typical startup characteristic from On/Off application at full load. CH3-On/Off, CH1-Vo1, CH2-Vo2

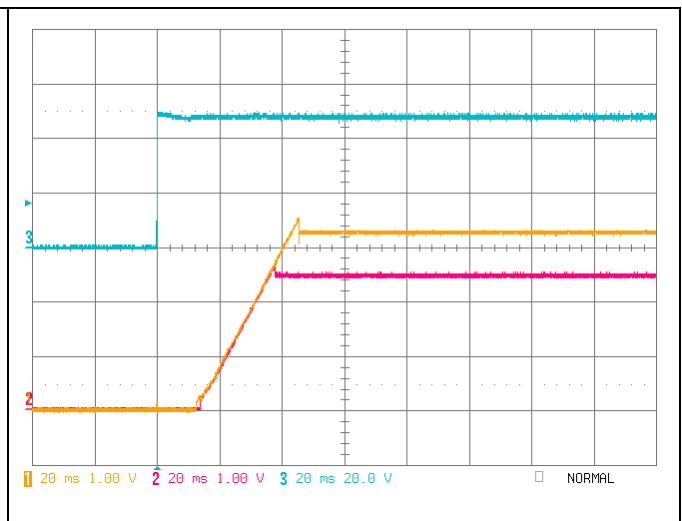

Typical startup characteristic from input voltage application at full load. CH3-Vin, CH1-Vo1, CH2-Vo2

**Electrical Characteristics (continued):**

**iQA48015A033M: 3.3V/2.5V, 15A Output**

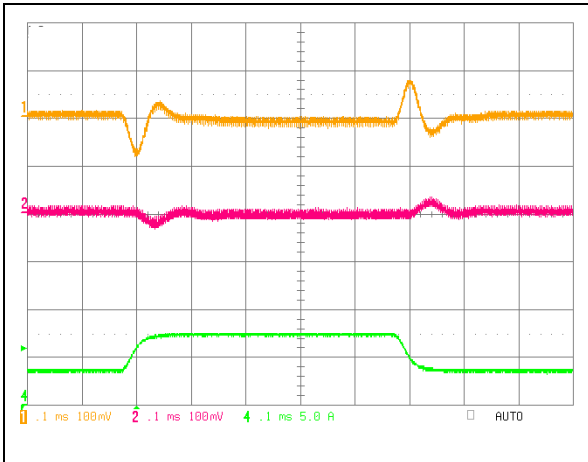

Typical Vo1 load transient response. Io1 step from 3.75A to 7.5A with 0.1A/uS, Io2=7.5A. CH1 – Vo1, CH2 – Vo2, CH4 – Io1.

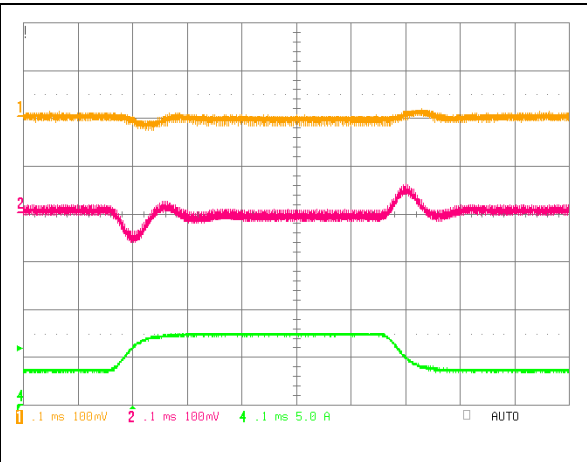

Typical Vo2 load transient response. Io2 step from 3.75A to 7.5A with 0.1A/uS, Io1=7.5A. CH1 – Vo1, CH2 – Vo2, CH4 – Io2.

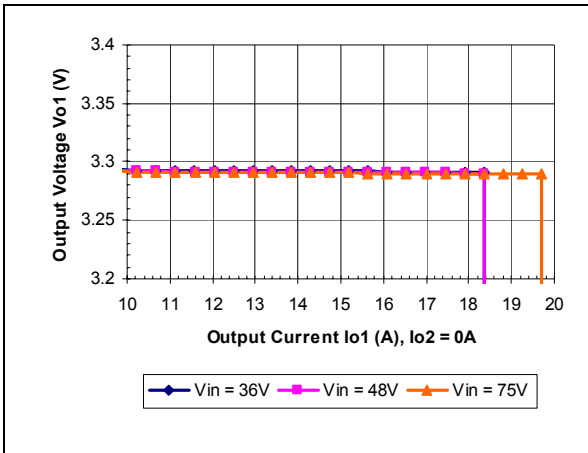

Typical Output 1 Current Limit Characteristics vs. Input Voltage at Ta=25 degrees.

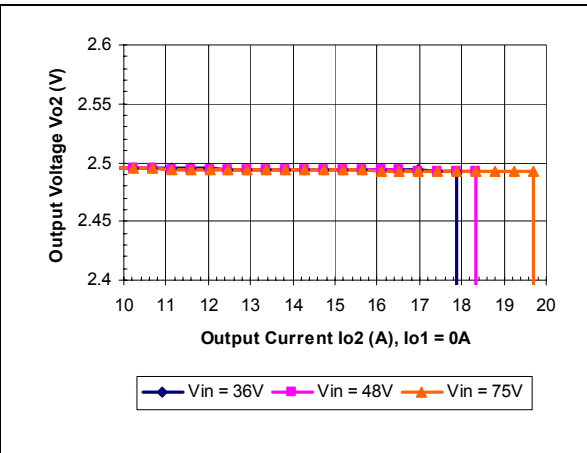

Typical Output 2 Current Limit Characteristics vs. Input Voltage at Ta=25 degrees.

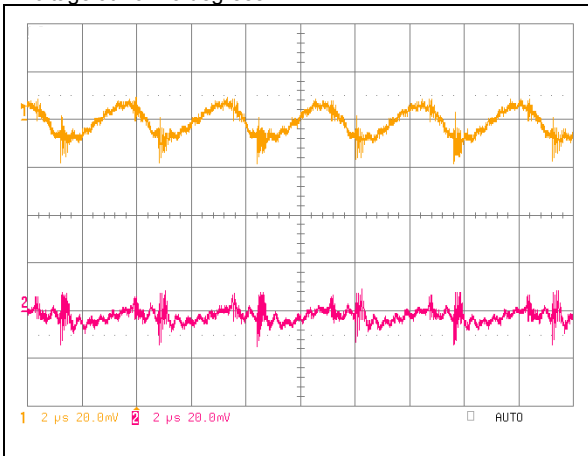

Typical Output Ripple at nominal Input voltage and full balanced load currents at Ta=25 degrees.

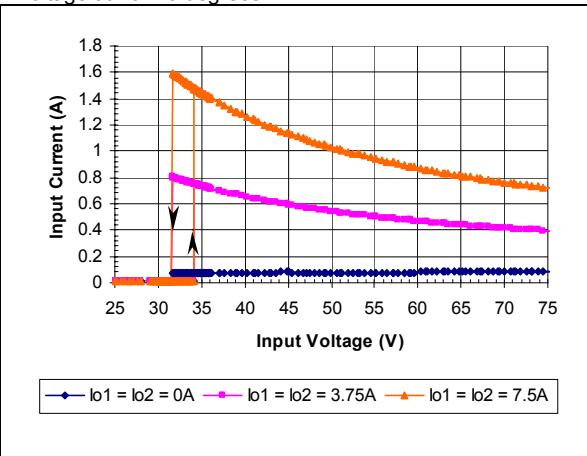

Typical Input Current vs. Input Voltage Characteristics.

## Electrical Characteristics (continued):

### iQA48015A033M: 3.3V/2.5V, 15A Output

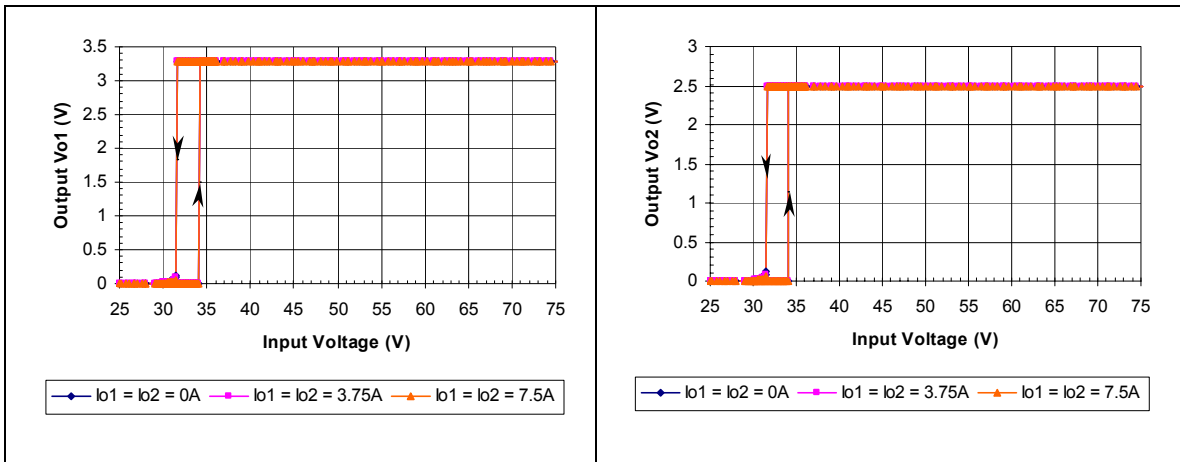

Typical Vo1 Output Voltage vs. Input Voltage Characteristics

Typical Vo2 Output Voltage vs. Input Voltage Characteristics

#### Trim up – tracking trim option

Trim from nominal (%)	+1	+2	+3	+4	+5	+6	+7	+8	+9	+10
Rup (kΩ)	46	20.4	12.1	7.9	5.2	3.5	2.2	1.3	.61	0

Rup is connected between Trim and RTN.

#### Trim down – tracking trim option

Trim from nominal (%)	-1	-2	-3	-4	-5	-6	-7	-8	-9	-10
Rdown (kΩ)	56.9	25	13.8	8.8	5.8	3.8	2.3	1.3	.43	0

Rdown is connected between Trim and Vout2.

Trim resistor values for output voltage adjustment – tracking trim option.

## Advance Data Sheet: Dualeta™ iQA Series – Dual Quarter Brick

### Electrical Data:

#### iQA48015A050M: 5V/3.3V, 15A Output

Characteristic	Min	Typ	Max	Unit	Notes & Conditions
Output Voltage Initial Setpoint Vout1 Vout2	4.92 3.25	5 3.3	5.08 3.35	Vdc Vdc	Vin=Vin,nom; Io=Io,max; Tc = 25°C
Output Voltage Tolerance Vout1 Vout2	4.85 3.2	5 3.3	5.15 3.4	Vdc Vdc	Over all rated input voltage, load, and temperature conditions to end of life
Efficiency	86*	87.5	---	%	Vin=Vin,nom; Io1=7.5A, Io2=7.5A; Tc = 25°C
Line Regulation	---	2	5*	mV	Vin=Vin,min to Vin,max
Load Regulation	---	5	15*	mV	Io=Io,min to Io,max
Temperature Regulation	---	10	75*	mV	Tc=Tc,min to Tc,max
Output Current	0	---	15	A	Sum of output currents, Io1+Io2
Output Current Limiting Threshold	---	17	---	A	Vo1 = 0.9*Vo,nom, Tc<Tc,max
Short Circuit Current	---	3	---	A	Vo = 0.25V, Tc = 25°C; average output current in current limit hiccup mode
Output Ripple and Noise Voltage Vout1 Vout2  Vout1 Vout2	--- ---  --- ---	40 35  10 10	80 70  --- ---	mVpp mvpp  mVrms mVrms	Measured with 47uF Tantalum and 1uF ceramic external capacitance – see input/output ripple measurement figure; BW = 20MHz
Output Voltage Adjustment Range Dual independent trim – standard Tracking trim option	1.5 90	--- ---	5.5 110	Vdc %Vout,nom	
Dynamic Response: Recovery Time	---	0.1	---	mS	di/dt = 0.1A/uS, Vin=Vin,nom; load step from 50% to 75% of Io,max, either output
Transient Voltage	---	100	---	mV	
Output Voltage Overshoot during startup Vout1 Vout2	--- ---	250 150	--- ---	mV mV	Io=Io,max, Tc=25°C
Switching Frequency	---	280	---	kHz	Fixed
Output Over Voltage Protection Dual independent trim – standard Vo1 Vo2 Tracking trim option Vo1 Vo2	5.6 --- 5.6 3.7	--- Vo1 --- ---	6.7* --- 7.5* 5.2*	V V V V	
External Load Capacitance	0	---	5000*&	uF	
Isolation Capacitance	---	1000	---	pF	
Isolation Resistance	10	---	---	MΩ	

\*Engineering Estimate

& Contact TDK Innoveta for applications that require additional capacitance or very low ESR capacitor banks.

## Electrical Characteristics:

### iQA48015A050M: 5V/3.3V, 15A Output

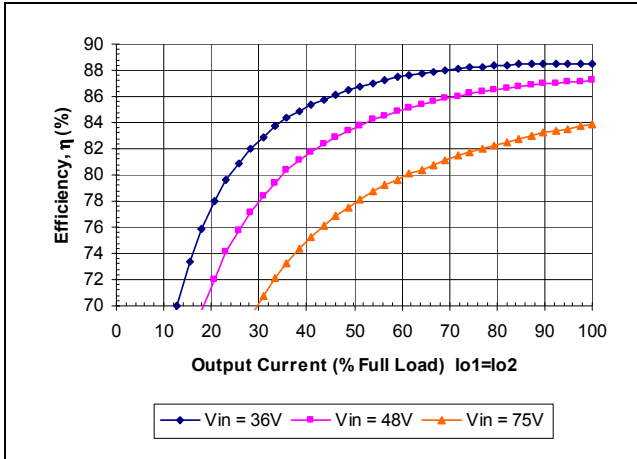

Typical Efficiency vs. Input Voltage at Ta=25°C.

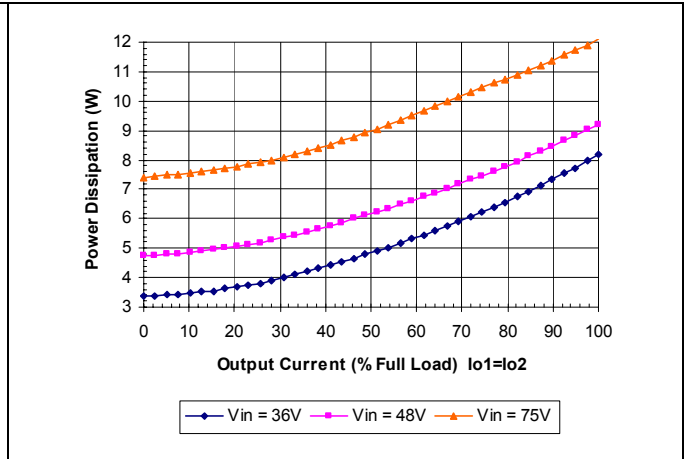

Typical Power Dissipation vs. Input Voltage at Ta=25°C.

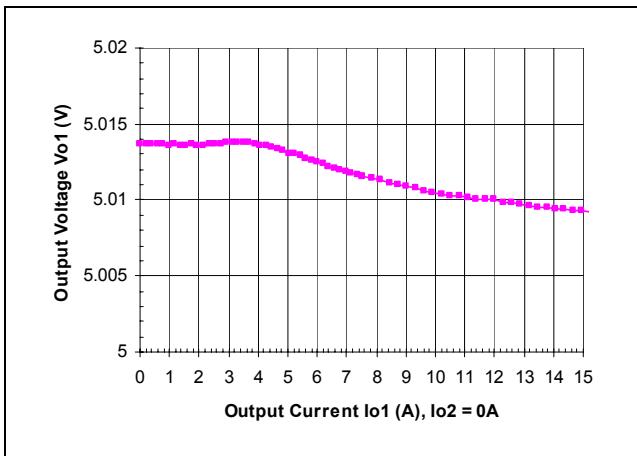

Typical Output 1 Voltage vs. Load Current at Ta = 25°C.

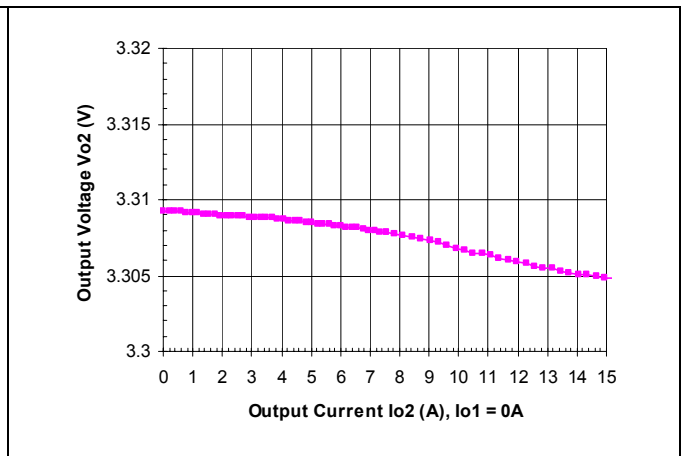

Typical Output 2 Voltage vs. Load Current at Ta = 25°C.

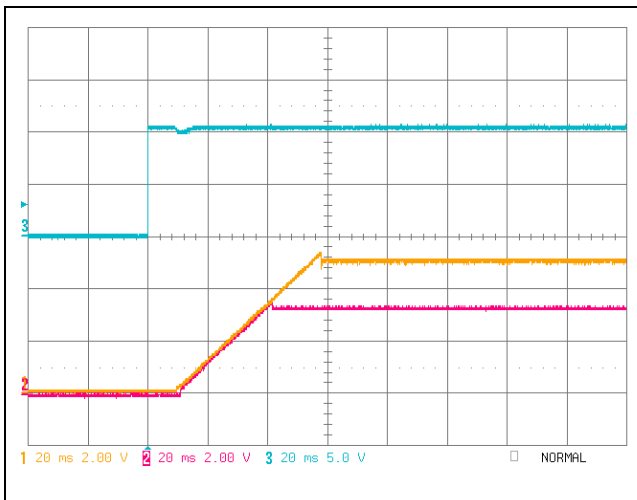

Typical startup characteristic from On/Off application at full load. CH3-On/Off, CH1-Vo1, CH2-Vo2

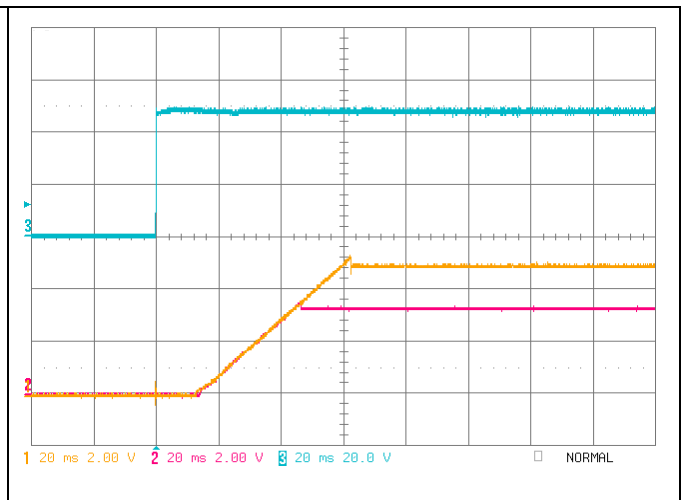

Typical startup characteristic from input voltage application at full load. CH3-Vin, CH1-Vo1, CH2-Vo2

**Electrical Characteristics (continued):**

**iQA48015A050M: 5V/3.3V, 15A Output**

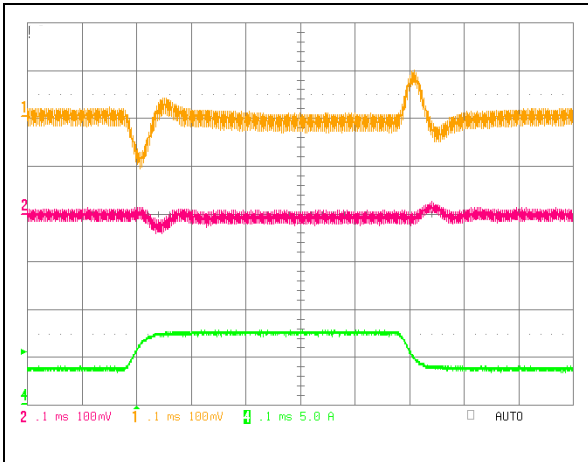

Typical Vo1 load transient response. Io1 step from 3.75A to 7.5A with 0.1A/uS, Io2=7.5A. CH1 – Vo1, CH2 – Vo2, CH4 – Io1.

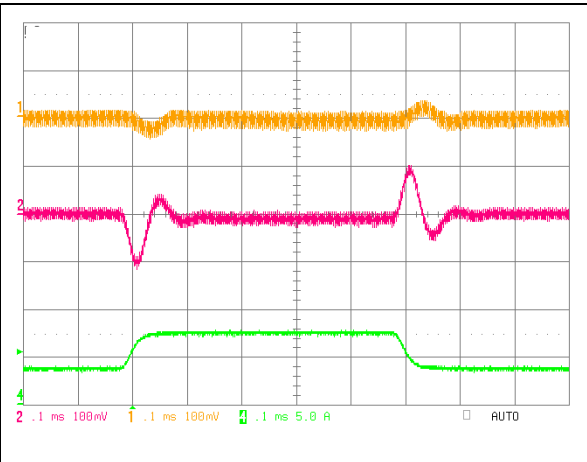

Typical Vo2 load transient response. Io2 step from 3.75A to 7.5A with 0.1A/uS, Io1=7.5A. CH1 – Vo1, CH2 – Vo2, CH4 – Io2.

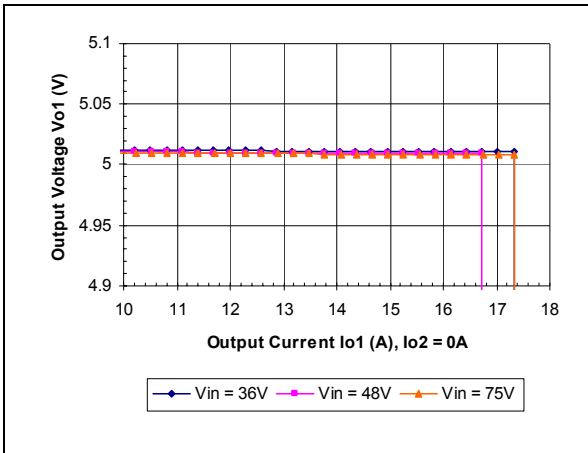

Typical Output 1 Current Limit Characteristics vs. Input Voltage at Ta=25 degrees.

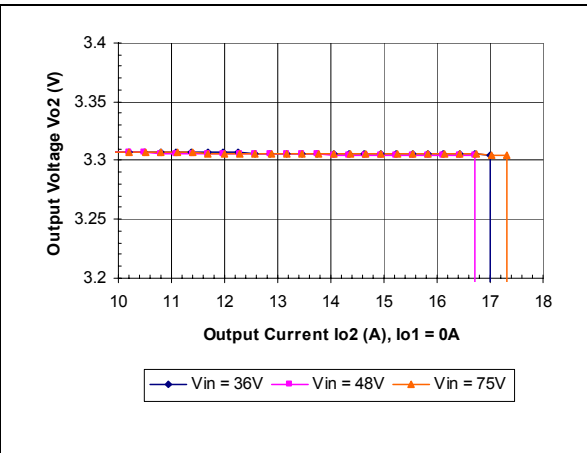

Typical Output 2 Current Limit Characteristics vs. Input Voltage at Ta=25 degrees.

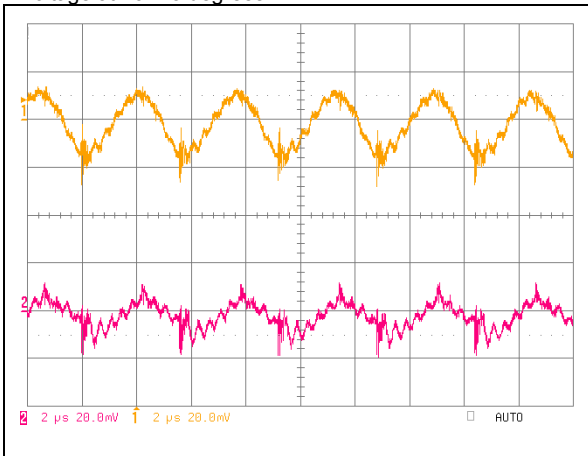

Typical Output Ripple at nominal Input voltage and full balanced load currents at Ta=25 degrees.

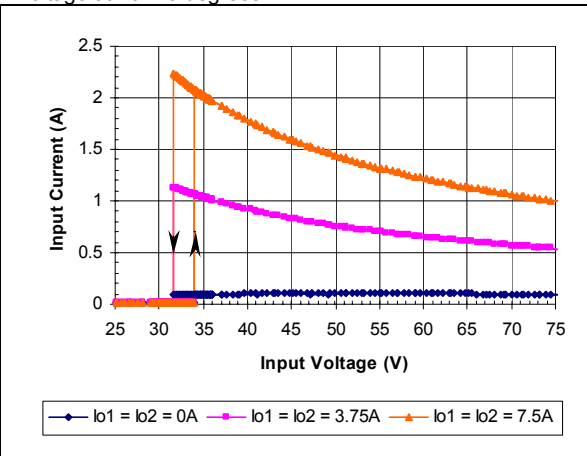

Typical Input Current vs. Input Voltage Characteristics.

## Electrical Characteristics (continued):

### iQA48015A050M: 5V/3.3V, 15A Output

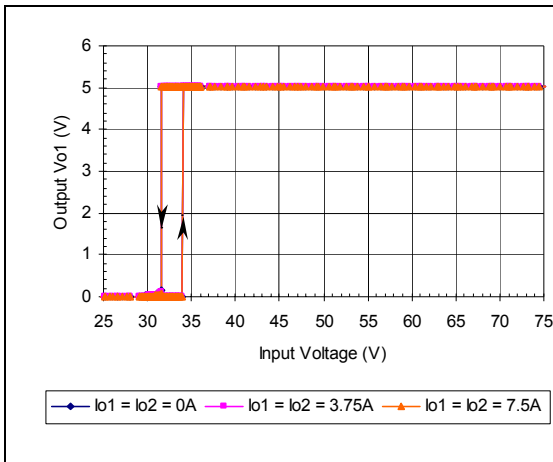

Typical Vo1 Output Voltage vs. Input Voltage Characteristics

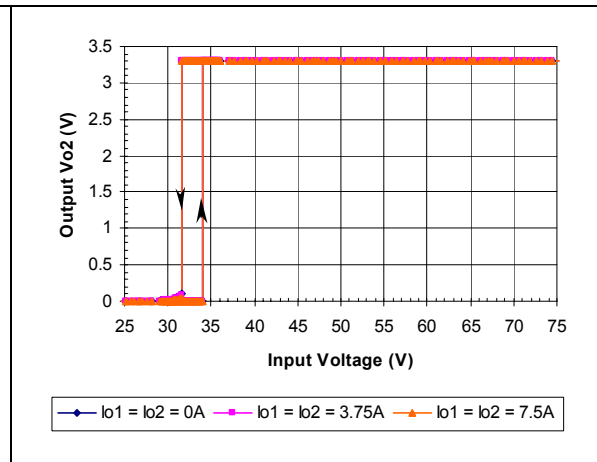

Typical Vo2 Output Voltage vs. Input Voltage Characteristics

#### Trim up – independent trim

Vout1 (V)	5.15	5.25	5.35	5.5
Trim from nominal (%Vo)	3%	5%	7%	10%
Rup1 (kΩ)	318	194	141	101

Rup1 is connected between Trim1 and Vout1.

Vout2 (V)	3.63	4.0	4.5	5
Trim from nominal (%Vo)	10%	21%	36%	52%
Rup2 (kΩ)	55	28	18	14

Rup2 is connected between Trim2 and Vout2.

$$R_{up} = \left[ \frac{3.01 V_{onom} (100 + \%Vo)}{1.225 (\%Vo)} - \frac{301 + 4.01 (\%Vo)}{\%Vo} \right] \cdot 1000$$

Trim up resistor values for output voltage adjustment – standard wide trim version.

#### Trim down – independent trim

Vout1 (V)	4.5	3.3	2.5	1.8
Trim from nominal (%Vo)	10%	34%	50%	64%
Rdown1 (kΩ)	26	4.8	2.0	0.69

Rdown1 is connected between Trim1 and RTN.

Vout2 (V)	2.97	2.5	1.8	1.5
Trim from nominal (%Vo)	10%	24%	45%	55%
Rdown2 (kΩ)	26	8.5	2.7	1.5

Rdown2 is connected between Trim2 and RTN.

$$R_{down} = \frac{301 - 4.01 (\%Vo)}{\%Vo} \cdot 1000$$

Trim down resistor values for output voltage adjustment – standard wide trim version.

#### Trim up – tracking trim option

Trim from nominal (%)	+1	+2	+3	+4	+5	+6	+7	+8	+9	+10
Rup (kΩ)	50	23	14	9.2	6.4	4.5	3.1	2.1	1.3	0

Rup is connected between Trim and RTN.

#### Trim down – tracking trim option

Trim from nominal (%)	-1	-2	-3	-4	-5	-6	-7	-8	-9	-10
Rdown (kΩ)	67	30	17	11	7.8	5.4	3.7	2.4	1.4	0

Rdown is connected between Trim and Vout2.

Trim resistor values for output voltage adjustment – tracking trim option.

## Thermal Performance:

### iQA48015A050M: 5V/3.3V, 15A Output

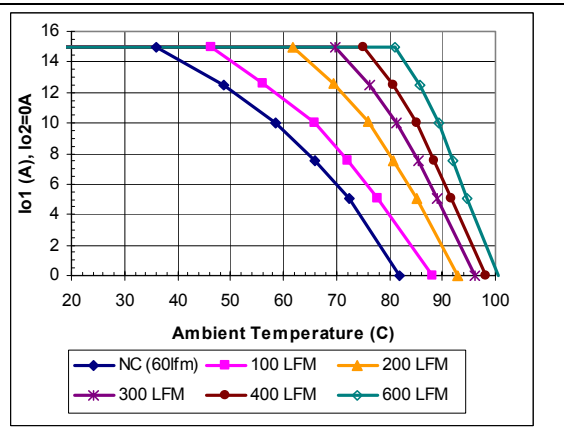
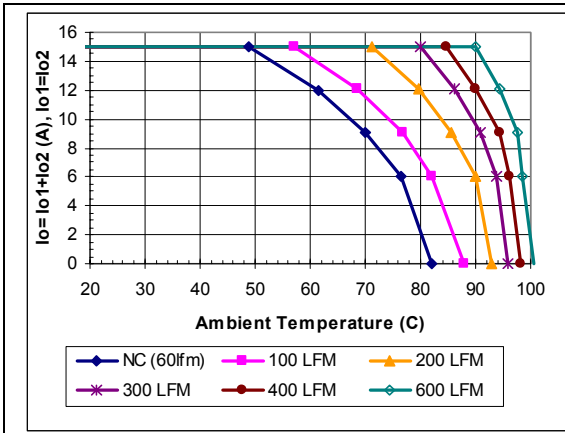

Maximum balanced load (Io1=Io2) output current vs. ambient temperature at nominal input voltage for airflow rates natural convection (60lfm) to 600lfm with airflow from pin 3 to pin 1.

Maximum Io1 output current (Io2=0A) vs. ambient temperature at nominal input voltage for airflow rates natural convection (60lfm) to 400lfm with air flow from pin 3 to pin 1.

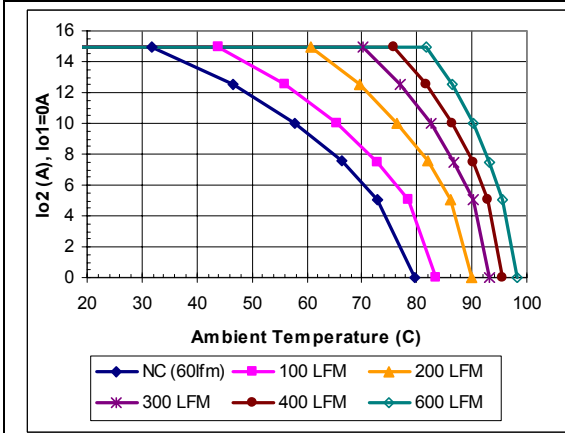

Maximum Io2 output current (Io1=0) vs. ambient temperature at nominal input voltage for airflow rates natural convection (60lfm) to 400lfm with air flow from pin 3 to pin 1.

The thermal curves provided and the example given above are based upon measurements made in Innoveta's experimental test setup that is described in the Thermal Management section. Due to the large number of variables in system design, Innoveta recommends that the user verify the module's thermal performance in the end application.

## Thermal Management:

An important part of the overall system design process is thermal management; thermal design must be considered at all levels to ensure good reliability and lifetime of the final system. Superior thermal design and ability to operate in severe application environments are key elements of a robust, reliable power module.

A finite amount of heat must be dissipated from the power module to the surrounding environment. This heat is transferred by the three modes of heat transfer: convection, conduction and radiation. While all three modes of heat transfer are present in every application, convection is the dominant mode of heat transfer in most applications. However, to ensure adequate cooling and proper operation, all three modes should be considered in a final system configuration.

The open frame design of the power module provides an air path to individual components. This air path improves heat conduction and convection to the surrounding environment, which reduces areas of heat concentration and resulting hot spots.

## Test Setup

The thermal performance data of the power module is based upon measurements obtained from a wind tunnel test with the setup shown below. This thermal test setup replicates the typical thermal environments encountered in most modern electronic systems with distributed power architectures. The electronic equipment in optical networking, telecom, wireless and advanced computer systems operate in similar environments and utilize vertically mounted PCBs or circuit cards in cabinet racks.

The power module, as shown in the figure, is mounted on a printed circuit board (PCB) and is vertically oriented within the wind tunnel. The cross section of the airflow passage is rectangular. The spacing between the top of the module or heatsink (where applicable) and a parallel facing PCB is kept at a constant (0.5 in). The power module orientation with respect to the airflow

direction can have a significant impact on the module's thermal performance.

## Thermal Derating:

For proper application of the power module in a given thermal environment, output current derating curves are provided as a design guideline in the

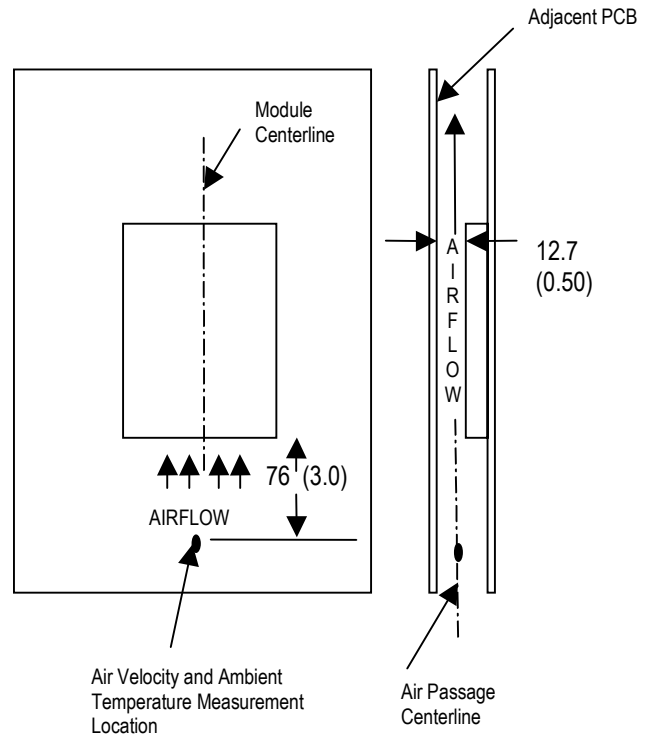

## Wind Tunnel Test Setup

**Dimensions are in millimeters and (inches).**

Thermal Performance section. The module temperature should be measured in the final system configuration to ensure proper thermal management of the power module. In all conditions, the power module should be operated below the maximum operating temperature shown on the de-rating curve. For improved design margins and enhanced system reliability, the power module may be operated at temperatures below the maximum rated operating temperature.

Heat transfer by convection can be enhanced by increasing the airflow rate that the power module experiences. The maximum output current of the power module is a function of ambient temperature ( $T_{AMB}$ ) and airflow rate as shown in the

thermal performance figures in the Thermal Performance section. The curves in the figures are shown for natural convection through 3 m/s (600 ft/min). The data for the natural convection condition has been collected at 0.3 m/s (60 ft/min) of airflow, which is the typical airflow generated by other heat dissipating components in many of the systems that these types of modules are used in. In the final system configurations, the airflow rate for the natural convection condition can vary due to temperature gradients from other heat dissipating components.

**Heatsink Usage:** For applications with demanding environmental requirements, such as higher ambient temperatures or higher power dissipation, the thermal performance of the power module can be improved by attaching a heatsink or cold plate. The iQA platform is designed with a base plate with four M3 X 0.5 through-threaded mounting fillings for attaching a heatsink or cold plate. The addition of a heatsink can reduce the airflow requirement, ensure consistent operation and extend reliability of the system. With improved thermal performance, more power can be delivered at a given environmental condition.

Standard heatsink kits are available from Innoveta Technologies for vertical module mounting in two different orientations (longitudinal – perpendicular to the direction of the pins and transverse – parallel to the direction of the pins) as shown in the heatsink Offering section. The heatsink kit contains four M3 x 0.5 steel mounting screws and a pre-cut thermal interface pad for improved thermal resistance between the power module and the heatsink. The screws should be installed using a torque-limiting driver set between 0.35-0.55 Nm (3-5 in-lbs).

During heatsink assembly, the base-plate to heatsink interface must be carefully managed. A thermal pad may be required to reduce mechanical-assembly-related stresses and improve the thermal connection. Please contact Innoveta Engineering for recommendations on this subject.

The system designer must use an accurate estimate or actual measure of the internal airflow rate and temperature when doing the heatsink thermal analysis. For each application, a review of the heatsink fin orientation should be completed to verify proper fin alignment with airflow direction to maximize the heatsink effectiveness. For Innoveta standard heatsinks, contact Innoveta Technologies for latest performance data.

### Operating Information

#### Over-Current Protection

The power modules have current limit protection to protect the module during output overload and short circuit conditions. During overload conditions, the power modules may protect themselves by entering a hiccup current limit mode. The modules will operate normally once the output current returns to the specified operating range. There is a typical delay of 100mS from the time an overload condition appears at the module output until the hiccup mode will occur.

#### Output Over-Voltage Protection

The power modules have a control circuit, independent of the primary control loop that reduces the risk of over voltage appearing at the output of the power module during a fault condition. If there is a fault in the primary regulation loop, the over voltage protection circuitry will cause the power module to enter a hiccup over-voltage mode once it detects that the output voltage has reached the level indicated in the Electrical Data section for the power module of interest. When the condition causing the over-voltage is corrected, the module will operate normally.

#### Thermal Protection

When the power module exceeds the maximum operating temperature, the module may turn-off to safeguard the power unit against thermal damage. The module will auto restart as the unit is cooled below the over temperature threshold.

### Remote On/Off

The power modules have an internal remote On/Off circuit. The user must supply an open-collector or compatible switch between the Vin (-) pin and the On/Off pin. The maximum voltage generated by the power module at the on/off terminal is 15V. The maximum allowable leakage current of the switch is 50uA. The switch must be capable of maintaining a low signal Von/off < 1.2V while sinking 1mA.

The standard on/off logic is positive logic. The power module will turn on if the On/Off is left open and will be off if the On/Off is connected to Vin (-). If the positive logic circuit is not being used, the On/Off should be left open.

An optional negative logic is available. The power module will turn on if the On/Off terminal is connected to Vin (-), and it will be off if the On/Off is left open. If the negative logic feature is not being used, On/Off should be shorted to Vin (-).

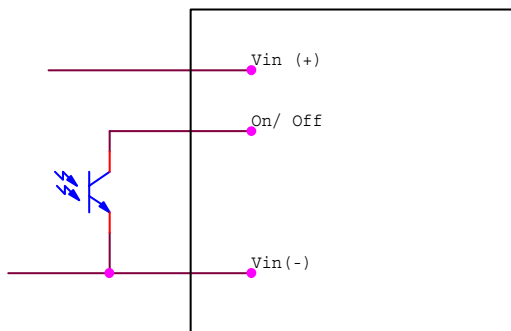

**On/Off Circuit for positive or negative logic**

### Output Voltage Adjustment

The output voltages of the power module may be adjusted by using an external resistor connected between the Trim terminal and either the Vo (+) or RTN terminal. If the output voltage adjustment feature is not used, the Trim pin(s) should be left open. Care should be taken to avoid injecting noise into the power module's trim pin. A small 0.01uF capacitor between the power module's trim pin and RTN pin may help avoid this.

Two trim configurations are offered on the iQA-series. The standard Dual Independent Trim offers wide range independent adjustment of either output, using two trim pins. The optional Single Tracking Trim adjusts both outputs together by 10% according to industry standard resistor tables. Only a single trim pin is provided.

### Dual independent Trim

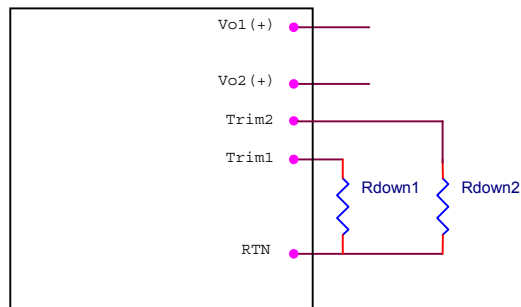

**Circuit to decrease output voltage**

With a resistor between the trim and RTN terminals, the output voltage is adjusted down. To adjust the output voltage down a percentage of Vout (%Vo) from Vo,nom, the trim resistor should be chosen according to the following equation:

$$R_{down} = \frac{301 - 4.01 \cdot (\%Vo)}{\%Vo} \cdot 1000$$

The current limit set point does not increase as the module is trimmed down, so the available output power is reduced.

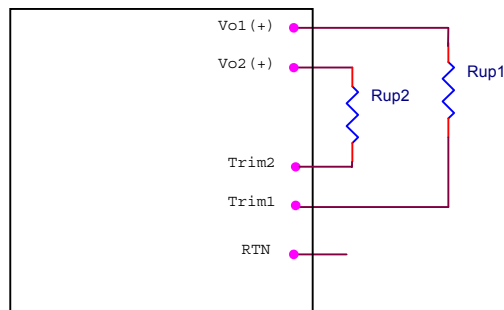

**Circuit to increase output voltage**

With a resistor between the trim and Vo (+) terminals, the output voltage is adjusted up. To adjust the output voltage up a percentage of Vout (%Vo) from Vo,nom the trim resistor should be chosen according to the following equation:

$$R_{up} = \left[ \frac{3.01 V_{onom} \cdot (100 + \%Vo)}{1.225 \cdot (\%Vo)} - \frac{301 + 4.01 \cdot (\%Vo)}{\%Vo} \right] \cdot 1000$$

The maximum power available from the power module is fixed. As the output voltage is trimmed up, the maximum output current must be decreased to maintain the maximum rated power of the module.

As the output voltage is trimmed, the output over-voltage set point is not adjusted. Trimming the output voltage too high may cause the output over voltage protection circuit to be triggered.

### Optional Tracking Trim

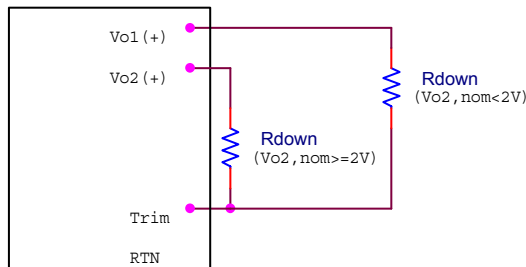

**Circuit to decrease output voltage**

With a resistor between the trim and Vo2(+) terminals, the output voltage is adjusted down. For models where the nominal set point of Vo2 is < 2V, the resistor is instead tied from trim to Vo1(+). Refer to the resistor selection tables in the Electrical Characteristics section for trim adjustment.

The current limit set point does not increase as the module is trimmed down, so the available output power is reduced.

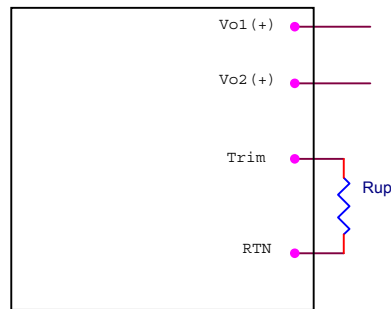

**Circuit to increase output voltage**

With a resistor between the Trim and RTN terminals, the output voltage is adjusted up. Refer to the resistor selection tables in the Electrical Characteristics section for trim adjustment.

The maximum power available from the power module is fixed. As the output voltage is trimmed up, the maximum output current must be decreased to maintain the maximum rated power of the module.

As the output voltage is trimmed, the output over-voltage set point is not adjusted. Trimming the output voltage too high may cause the output over voltage protection circuit to be triggered.

**EMC Considerations:** Innoveta power modules are designed for use in a wide variety of systems and applications. For assistance with designing for EMC compliance, please contact Innoveta technical support.

### Input Impedance:

The source impedance of the power feeding the DC/DC converter module will interact with the DC/DC converter. To minimize the interaction, a 10-100uF input electrolytic capacitor should be present if the source inductance is greater than 4uH.

## Input/Output Ripple and Noise Measurements

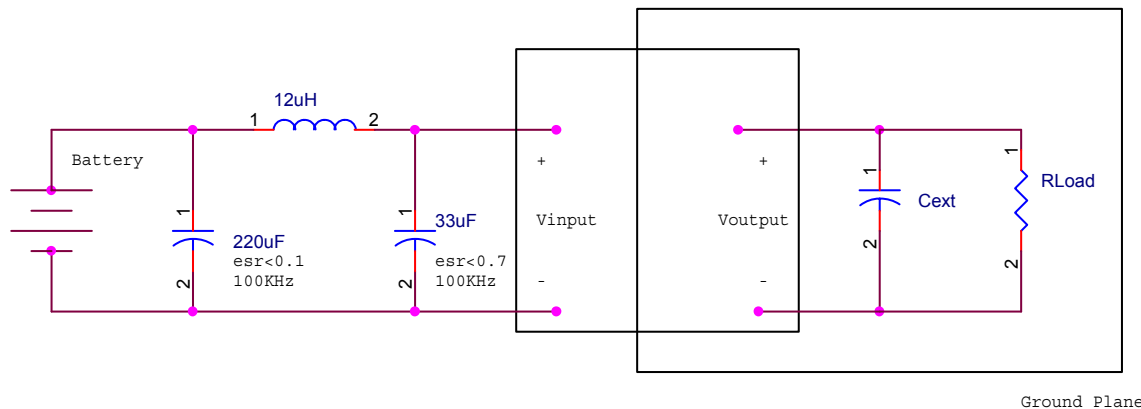

The input reflected ripple is measured with a current probe and oscilloscope. The ripple current is the current through the 12uH inductor.

The output ripple measurement is made approximately 9 cm (3.5 in.) from the power module using an oscilloscope and BNC socket. The capacitor  $C_{ext}$  is located about 5 cm (2 in.) from the power module; its value varies from code to code and is found on the electrical data page for the power module of interest under the ripple & noise voltage specification in the Notes & Conditions column.

## Reliability

The power modules are designed using TDK Innoveta's stringent design guidelines for component derating, product qualification, and design reviews. Early failures are screened out by both burn-in and an automated final test.

Improper handling or cleaning processes can adversely affect the appearance, testability, and reliability of the power modules. Contact Innoveta technical support for guidance regarding proper handling, cleaning, and soldering of TDK Innoveta's power modules.

## Quality

TDK Innoveta's product development process incorporates advanced quality planning tools such as FMEA and Cpk analysis to ensure designs are robust and reliable. All products are assembled at ISO certified assembly plants.

## Warranty

TDK Innoveta's comprehensive line of power solutions includes efficient, high-density DC-DC converters. TDK Innoveta offers a three-year limited warranty. Complete warranty information is listed on our web site or is available upon request from TDK Innoveta.



## Advance Data Sheet: Dualeta™ iQA Series – Dual Quarter Brick

### Safety Considerations

For safety agency approval of the system in which the DC-DC power module is installed, the power module must be installed in compliance with the creepage and clearance requirements of the safety agency. The isolation is basic insulation. For applications requiring basic insulation, care must be taken to maintain minimum creepage and clearance distances when routing traces near the power module.

As part of the production process, the power modules are hi-pot tested from primary and secondary at a test voltage of 1500Vdc.

To preserve maximum flexibility, the power modules are not internally fused. An external input line normal blow fuse with a maximum value of 15A is required by safety agencies. A lower value fuse can be selected based upon the maximum dc input current and maximum inrush energy of the power module.

When the supply to the DC-DC converter is less than 60Vdc, the power module meets all of the requirements for SELV. If the input voltage is a hazardous voltage that exceeds 60Vdc, the output can be considered SELV only if the following conditions are met:

- 1) The input source is isolated from the ac mains by reinforced insulation.
- 2) The input terminal pins are not accessible.
- 3) One pole of the input and one pole of the output are grounded or both are kept floating.
- 4) Single fault testing is performed on the end system to ensure that under a single fault, hazardous voltages do not appear at the module output.



3320 Matrix Drive  
Suite 100  
Richardson, Texas 75082

Phone (877) 498-0099 Toll Free  
(469) 916-4747

Fax (877) 498-0143 Toll Free  
(214) 239-3101

[support@tdkinnoveta.com](mailto:support@tdkinnoveta.com)  
<http://www.tdkinnoveta.com/>

Information furnished by TDK Innoveta is believed to be accurate and reliable. However, TDK Innoveta assumes no responsibility for its use, nor for any infringement of patents or other rights of third parties, which may result from its use. No license is granted by implication or otherwise under any patent or patent rights of TDK Innoveta. TDK Innoveta components are not designed to be used in applications, such as life support systems, wherein failure or malfunction could result in injury or death. All sales are subject to TDK Innoveta's Terms and Conditions of Sale, which are available upon request. Specifications are subject to change without notice.

 is a trademark or registered trademark of TDK Corporation.