

Datasheet DC-DC Power Modules
Veta[®] iHA24008A280V* Half Brick Series
24V Input, 28V/8A Output

TDK Innoveta Inc

3320 Matrix Drive, Suite 100
Richardson, Texas 75082

Phone (877) 498-0099 Toll Free
(459) 916-4747

Fax (877) 498-0143 Toll Free
(214) 239-3101

support@tdkinnoveta.com
<http://www.tdkinnoveta.com/>

Information furnished by TDK Innoveta is believed to be accurate and reliable. However, TDK Innoveta assumes no responsibility for its use, nor for any infringement of patents or other rights of third parties, which may result from its use. No license is granted by implication or otherwise under any patent or patent rights of TDK Innoveta. TDK Innoveta components are not designed to be used in applications, such as life support systems, wherein failure or malfunction could result in injury or death. All sales are subject to TDK Innoveta's Terms and Conditions of Sale, which are available upon request. Specifications are subject to change without notice. TDK logo is a trademark or registered trademark of TDK Corporation.

Platform Overview:

Veta[®] iHA24 Series DC-DC Power Modules 24V Input, 28V/8A or 225W Output Half-Brick



The Veta[®] iHA24 Series power modules operate over a wide 19 – 36Vdc input voltage range and provide one regulated dc output voltage that is electrically isolated from the input. Its 91% efficiency and superior thermal performance make the Veta[®] Family of power modules ideally suited for power-hungry applications in demanding thermal environments. This rugged building block is designed to serve as the core of your high reliability system. A wide output voltage trim range and remote sensing are standard features enhancing versatility.

Standard Features:

- Standard Half Brick footprint
- High efficiency, 91% typical
- Wide output trim voltage
- Up to 8A of true usable current
- Industry-leading output power:: up to 225W
- Monotonic start-up
- Monotonic start-up into a pre-biased output
- Basic insulation – 1500 Vdc
- Constant switching frequency
- Auto-recovery protection:
 - Input under and over voltage
 - Current limit
 - Short circuit
 - Thermal limit
- Latched output over voltage protection
- High reliability open frame, surface-mount construction
- Baseplate for improved thermal management
- UL 60950 (US and Canada), VDE 0805, CB scheme (IEC950), CE Mark (EN60950)
- Multiple patents pending

Optional Features:

- Remote on/off (negative logic)
- Auto-recovery output over voltage protection
- Short Thru-hole pins 2.79 mm (0.110")

Ordering information:

Product Identifier	Package Size	Platform	Input Voltage	Output Current/Power	Output Units	Main Output Voltage	# of Outputs	Safety Class	Feature Set
i	H	A	24	008	A	280	V	- 0	00
TDK Innoveta	Half Brick	Veta®	19-36V	8	Amps	280 – 28V	Single		00 – Standard

Feature Set	On/Off Logic	Omit pin3	Output OVP	Pin Length
00	Positive	No	Latching	0.145"
01	Negative	No	Latching	0.145"
02	Positive	Yes	Auto-Recovery	0.145"
03	Negative	Yes	Auto-Recovery	0.145"
04	Positive	No	Latching	0.110"
05	Negative	No	Latching	0.110"
06	Positive	Yes	Auto-Recovery	0.110"
07	Negative	Yes	Auto-Recovery	0.110"



Product Offering:

Code	Input Voltage	Output Voltage	Output Current	Maximum Output Power	Efficiency
iHA24008A280V-000	19V to 36V	28.0V	8A	225W	91%

TDK Innoveta Inc

3320 Matrix Drive, Suite 100
Richardson, Texas 75082

Phone (877) 498-0099 Toll Free
(469) 916-4747

Fax (877) 498-0143 Toll Free
(214) 239-3101

support@tdkinnoveta.com
<http://www.tdkinnoveta.com/>

Mechanical Specification:

Unless otherwise specified tolerances are: $x.x \pm 0.5 \text{ mm}$ [$x.xx \pm 0.02 \text{ in.}$], $x.xx \pm 0.25 \text{ mm}$ [$x.xxx \pm 0.010 \text{ in.}$]

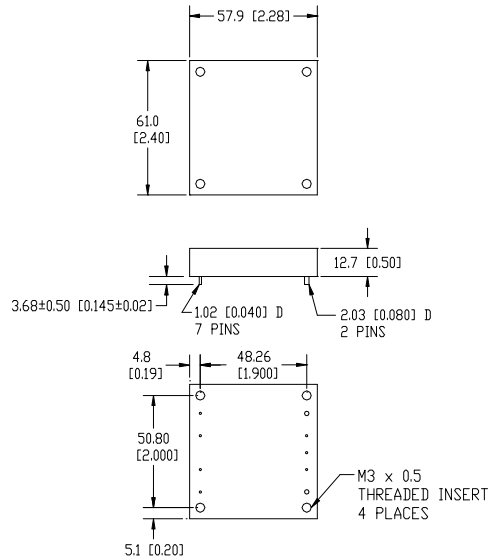

Recommended Hole Pattern: (top view)

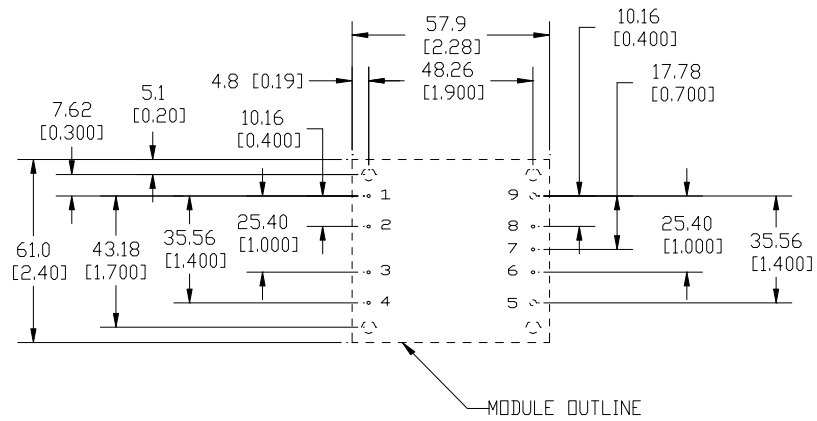

Pin Assignment:

PIN	FUNCTION	PIN	FUNCTION
1	Vin (+)	7	Trim
2	On/Off	8	Sense (+)
3	Case (Omit – optional)	9	Vout (+)
4	Vin (-)		
5	Vout (-)		
6	Sense (-)		

Absolute Maximum Ratings:

Stress in excess of Absolute Maximum Ratings may cause permanent damage to the device.

Characteristic	Min	Max	Unit	Notes & Conditions
Continuous Input Voltage	-0.5	50	Vdc	
Isolation Voltage	---	1500	Vdc	
Storage Temperature	-55	125	°C	
Operating Temperature Range (Tc)	-40	110*	°C	Maximum base plate temperature. Measured at the location specified in the thermal measurement figure.

- Engineering estimate

Common Input Characteristics:

Unless otherwise specified, specifications apply over all Rated Input Voltage, Resistive Load, and Temperature conditions.

Characteristic	Min	Typ	Max	Unit	Notes & Conditions
Operating Input Voltage	19	24	36	Vdc	When 18V = Vin < 19V, the module will continue to operate, but the output voltage regulation may be out of spec at full load condition
Turn-on Voltage	18	18.3	19	Vdc	
Turn-off Voltage	16.5	17.8	18	Vdc	
Hysteresis	---	0.5	---	Vdc	
Input High Voltage Turn-off	36.1	36.9	---	Vdc	
Input High Voltage Turn-on	35.4	36.2	---	Vdc	
Hysteresis	---	0.7	---	Vdc	
Startup Delay Time from application of input voltage	---	15	30	mS	Vo = 0 to 0.1*Vo,nom; on/off =on, Io=Io,max, Tc=25°C
Startup Delay Time from on/off	---	10	30	mS	Vo = 0 to 0.1*Vo,nom; Vin = Vi,nom, Io=Io,max,Tc=25°C
Inrush Transient	---	---	0.02	A ² s	

- * Engineering estimate

Electrical Data:

Input Characteristic	Min	Typ	Max	Unit	Notes & Conditions
Maximum Input Current	---	---	15*	A	Vin = 0 to Vin,max, Io,max, Vo=Vo,nom
Output Voltage Rise Time	---	20	---	mS	Io=Io,max,Tc=25°C, Vo=0.1 to 0.9*Vo,nom
Input Reflected Ripple	---	6.9	---	mApp	See input/output ripple measurement figure; BW = 20 MHz
Input Ripple Rejection	---	37	---	dB	@120Hz

- * Engineering estimate

Electrical Data (continued):

Output Characteristic	Min	Typ	Max	Unit	Notes & Conditions
Output Voltage Initial Setpoint	27.5	28.0	28.5	Vdc	Vin=Vin,nom; Io=Io,max; Tc = 25°C
Output Voltage Tolerance	27.1	---	28.9	Vdc	Over all rated input voltage, load, and temperature conditions to end of life
Efficiency	---	91	---	%	Vin=Vin,nom; Io=Io,max; Tc = 25°C
Line Regulation	---	10	30*	mV	Vin=Vin,min to Vin,max
Load Regulation	---	10	50*	mV	Io=Io,min to Io,max
Temperature Regulation	---	85	200*	mV	Tc=Tc,min to Tc,max
Output Current	0	---	8	A	At loads less than 25% of Io,max the module will continue to regulate the output voltage, but the output ripple may increase
Output Current Limiting Threshold	8.1	10	12	A	Vo = 0.9*Vo,nom, Tc<Tc,max
Short Circuit Current	---	16	---	A	Vo = 0.25V, Tc = 25°C
Output Ripple and Noise Voltage	---	300	475	mVpp	Measured across one 200uF electrolytic capacitor, one 10uF, one 1uF and one 0.1uF ceramic capacitors – see input/output ripple measurement figure; BW = 20MHz
	---	90	150	mVrms	
Output Voltage Adjustment Range	50	---	110	%Vo,nom	
Output Voltage Sense Range	---	---	10	%Vo,nom	
Dynamic Response: Recovery Time	---	0.25	0.35	mS	di/dt = 0.1A/uS, Vin=Vin,nom; load step from 50% to 75% of Io,max with 200uF ext. cap
Transient Voltage	---	270	---	mV	
Output Voltage Overshoot during startup	---	0	---	mV	Io=Io,max, Tc=25°C
Switching Frequency	---	300	---	kHz	Fixed
Output Over Voltage Protection	---	33	---	V	
External Load Capacitance	200	---	3000**	uF	
Isolation Capacitance	---	2000	---	pF	
Isolation Resistance	10	---	---	MΩ	
Vref		1.225		V	Required for trim calculation

* Engineering Estimate

** Contact TDK Innoveta for applications that require additional capacitance

Caution: The power modules are not internally fused. An external input line normal blow fuse with a maximum value of 20A is required, see the Safety Considerations section of the data sheet.

Electrical Characteristics:

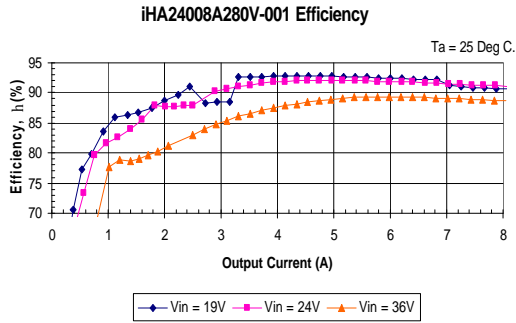

iHA24008A280V-001 Typical Efficiency vs. Output Current at Ta=25 degrees.

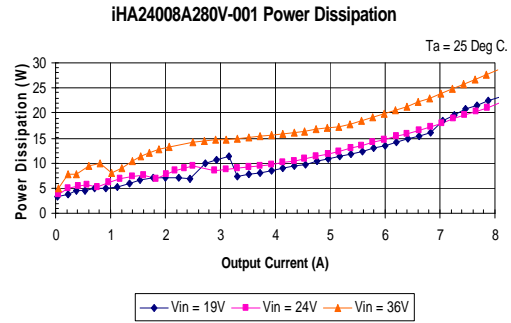

iHA24008A280V-001 Typical Power Dissipation vs. Output current at Ta=25 degrees

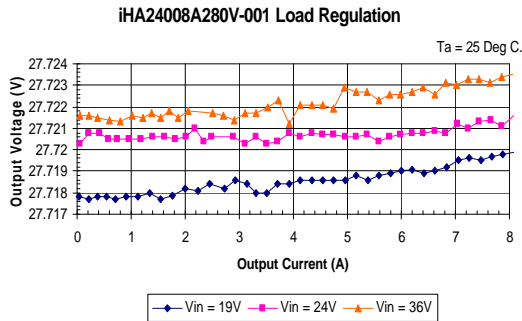

iHA24008A280V-001 Typical Output Voltage vs. Load Current at Ta = 25 degrees

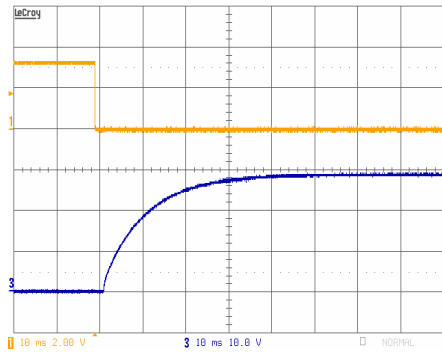

iHA24008A280V-001 Typical startup characteristic from on/off at full load. Upper trace - on/off signal, lower trace - output voltage

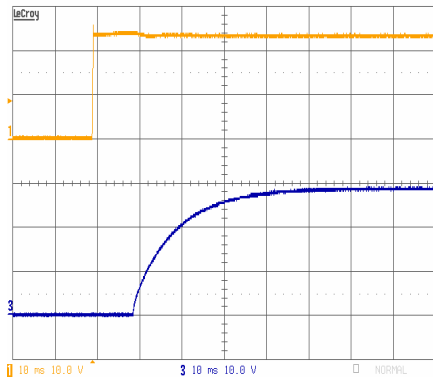

iHA24008A280V-001 Typical startup characteristic from input voltage application at full load. Upper trace - input voltage, lower trace - output voltage

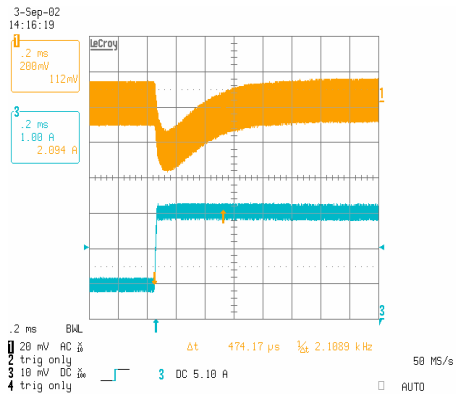

iHA24008A280V-001 Typical transient response. Load step from 50% to 75% of full load with 0.1A/uS. Lower trace - output current, upper trace - output voltage

Electrical Characteristics (continued):

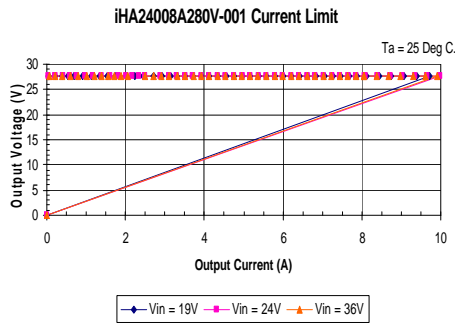

iHA24008A280V-001 Typical Output Current Limit Characteristics vs. Input Voltage at Ta=25 degrees.

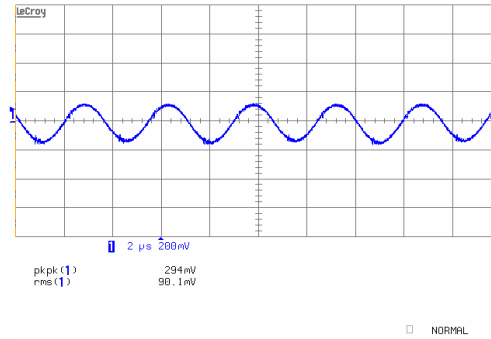

iHA24008A280V-001 Typical Output Ripple at nominal Input voltage and full load with external capacitors 200uF Al +10uF+1uF+0.1uF ceramic at Ta=25 degrees

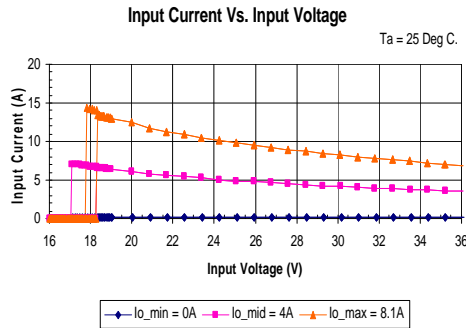

iHA24008A280V-001 Typical Input Current vs. Input Voltage Characteristics at Ta=25 degrees.

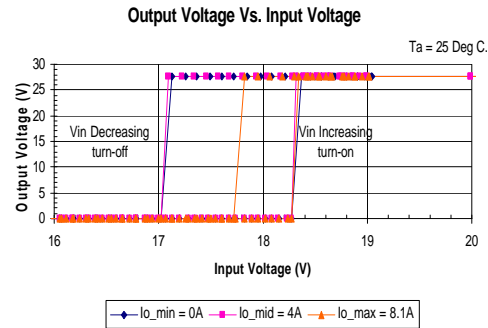

iHA24008A280V-001 Typical Output Voltage vs. Input Voltage Turn-on / Turn-off Characteristics – low voltage at Ta=25 degrees.

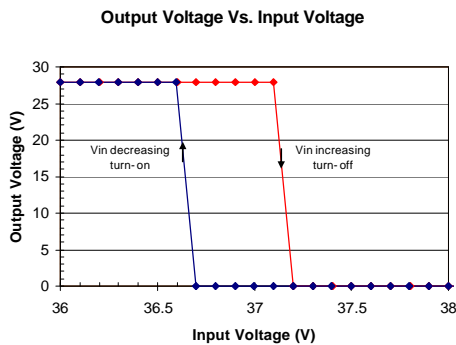

iHA24008A280V-001 Typical Output Voltage vs. Input Voltage Turn-on / Turn-off Characteristics – high voltage at Ta=25 degrees.

% Change of Vout	Trim Down Resistor (Kohm)	% Change of Vout	Trim Up Resistor (Kohm)
-3%	31.33K	+3%	749.4K
-5%	18K	+5%	458.0K
-10%	8K	+10%	239.43K

e.g. trim up 5%

$$R_{up} = \frac{\left[\frac{28}{1.225} - 2 \right] \cdot (1 + 5\%) + 1}{5\%} = 458.0 (k\Omega)$$

iHA24008A280V-001 Calculated resistor values for output voltage adjustment

Electrical Characteristics (continued):

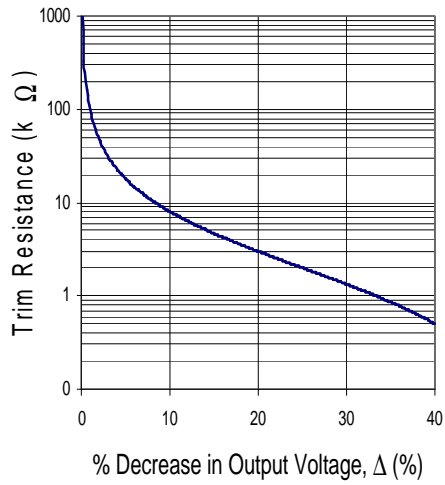

iHA24008A280V-001 Trim down curve for output voltage adjustment

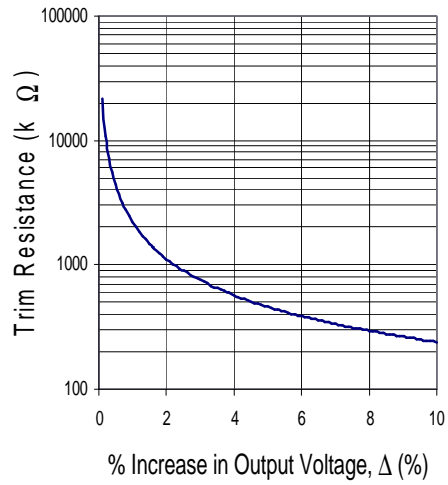

iHA24008A280V-001 Trim up curve for output voltage adjustment

Thermal Performance:

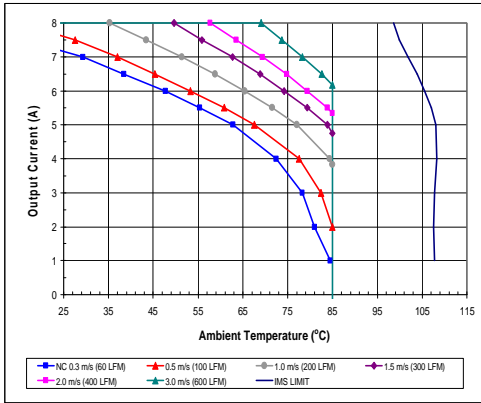

iHA24008A280V-001 maximum output current vs. ambient temperature at nominal input voltage for airflow rates natural convection 0.3 m/s (60lfm) to 3.0m/s (600lfm) with airflow from output to input.

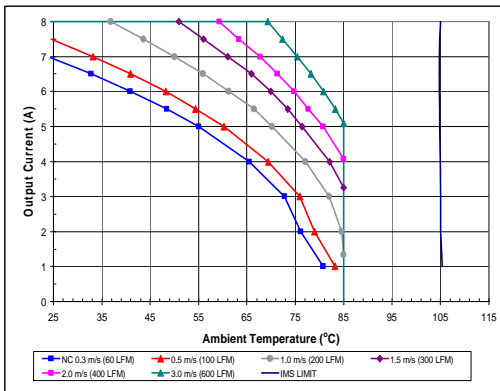
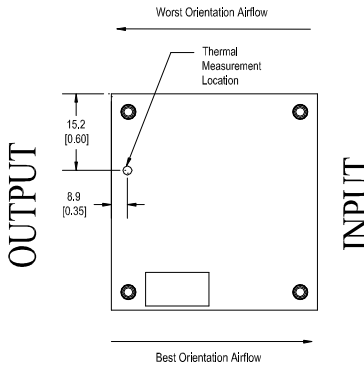

iHA24008A280V-001 maximum output current vs. ambient temperature at nominal input voltage for airflow rates natural convection 0.3 m/s (60lfm) to 3.0m/s (600lfm) with airflow from input to output.

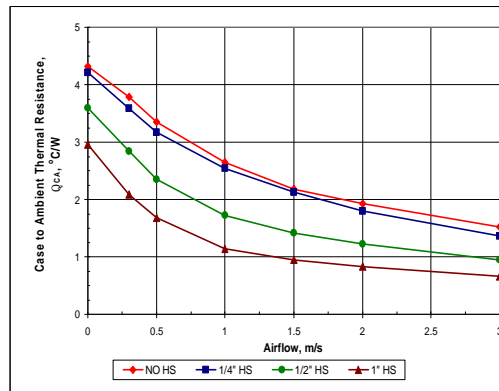

iHA24008A280V-001 Case to Ambient Thermal Resistance vs. Airflow rate

Thermal Performance (continued):

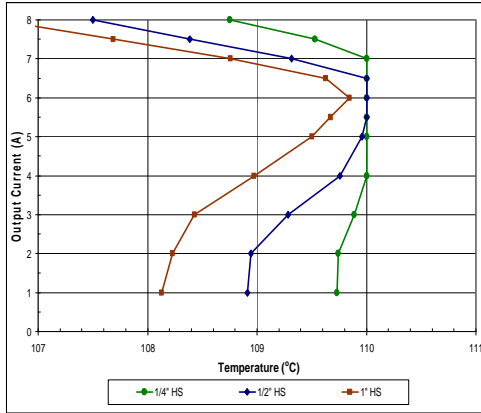

iHA24008A280V-001 with heatsink maximum Output Current vs. maximum allowable IMS Temperature at nominal input voltage with airflow from output to input.

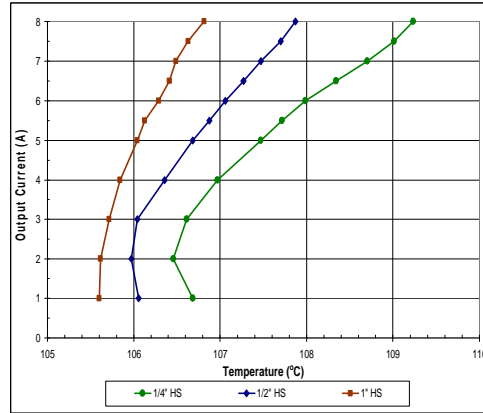

iHA24008A280V-001 with heatsink maximum Output Current vs. maximum allowable IMS Temperature at nominal input voltage with airflow from input to output.

Example: To estimate the maximum temperature at which an iHA24008A280V* Module can provide full load with 0.5 m/s (100 lfm) of airflow, at nominal line (24V) using a 1/2" heatsink with the best orientation, one must first look at the Power Dissipation vs. input voltage and Output Current plot. From this plot, it can be seen that the iHA24 dissipates 18.8W* of power (P_d) at full load. From the Case to Ambient Thermal Resistance vs. Airflow Rate curve, R_{ca} is 2.35°C/W. From the Output Current vs. maximum allowable IMS Temperature plot for the best orientation heatsink application, it can be seen that the maximum allowable IMS temperature at the thermal measurement location (T_c) is 107.5°C. From the governing equation for the overall thermal resistance of the module, $T_c - T_a = P_d \times R_{ca}$, the maximum ambient temperature (T_a) is determined to be 63.3°C.

Complete thermal de-rating and maximum IMS temperature curves without or with a heatsink (1/4", 1/2" or 1") are available upon request from TDK Innoveta.

* Please note that the Power Dissipation curve is for $T_{amb} = 25^\circ\text{C}$. At higher temperatures, power dissipation may be higher. Consult with TDK Innoveta if operating at high ambient temperatures.

The thermal curves provided are based upon measurements made in TDK Innoveta's experimental test setup that is described in the Thermal Management section. Due to the large number of variables in system design, TDK Innoveta recommends that the user verify the module's thermal performance in the end application. The critical component should be thermo-coupled and monitored, and should not exceed the temperature limit specified in the derating curve above. It is critical that the thermocouple be mounted in a manner that gives direct thermal contact otherwise significant measurement errors may result.

Thermal Management:

An important part of the overall system design process is thermal management; thermal design must be considered at all levels to ensure good reliability and lifetime of the final system. Superior thermal design and the ability to operate in severe application environments are key elements of a robust, reliable power module.

A finite amount of heat must be dissipated from the power module to the surrounding environment. This heat is transferred by the three modes of heat transfer: convection, conduction and radiation. While all three modes of heat transfer are present in every application, convection is the dominant mode of heat transfer in most applications. However, to ensure adequate cooling and proper operation, all three modes should be considered in a final system configuration.

The open frame design of the power module provides an air path to individual components. This air path improves convection cooling to the surrounding environment, which reduces areas of heat concentration and resulting hot spots.

Test Setup: The thermal performance data of the power module is based upon measurements obtained from a wind tunnel test with the setup shown in the wind tunnel figure. This thermal test setup replicates the typical thermal environments encountered in most modern electronic systems with distributed power architectures. The electronic equipment in networking, telecom, wireless, and advanced computer systems operates in similar environments and utilizes vertically mounted (PCBs) or circuit cards in cabinet racks.

The power module is mounted on a 0.062 inch thick, 6 layer, 2oz/layer PCB and is vertically oriented within the wind tunnel. Power is routed on the internal layers of the PCB. The outer copper layers are thermally decoupled from the converter to better simulate the customer's application. This also results in a more conservative derating.

The cross section of the airflow passage is rectangular with the spacing between the

top of the module and a parallel facing PCB kept at a constant (0.5 in). The power module's orientation with respect to the airflow direction can have a significant impact on the unit's thermal performance.

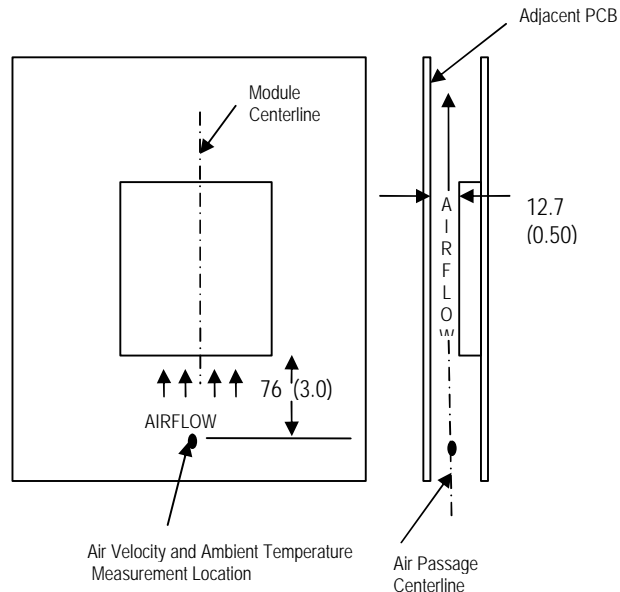

Wind Tunnel Test Setup Figure
Dimensions are in millimeters (inches)

Thermal Derating: For proper application of the power module in a given thermal environment, output current derating curves are provided as a design guideline in the Thermal Performance section for the power module of interest. The module temperature should be measured in the final system configuration to ensure proper thermal management of the power module. For thermal performance verification, the module temperature should be measured at the location indicated in the thermal measurement location figure in the Thermal Performance section for the power module of interest. In all conditions, the power module should be operated below the maximum operating temperature shown on the derating curve. For improved design margins and enhanced system reliability, the power module may be operated at temperatures below the maximum rated operating temperature.

Heat transfer by convection can be enhanced by increasing the airflow rate that the power module experiences. The maximum output current of the power module is a function of ambient temperature (T_{AMB}) and airflow rate as shown in the thermal performance figures on the thermal performance page for the power module of interest. The curves in the figures are shown for natural convection through 3 m/s (600 ft/min). The data for the natural convection condition has been collected at 0.3 m/s (60 ft/min) of airflow which is the typical airflow generated by other heat dissipating components in many of the systems that these types of modules are used in. In the final system configurations, the airflow rate for the natural convection condition can vary due to temperature gradients from other heat dissipating components.

Heatsink Usage: For applications with demanding environmental requirements, such as higher ambient temperatures or higher power dissipation, the thermal performance of the power module can be improved by attaching a heatsink or cold plate. The iHx platform is designed with a base plate with four M3 X 0.5 through-threaded mounting fillings for attaching a heatsink or cold plate. The addition of a heatsink can reduce the airflow requirement and ensure consistent operation and extended reliability of the system. With improved thermal performance, more power can be delivered at a given environmental condition.

Standard heatsink kits are available from TDK Innoveta for vertical module mounting in two different orientations (longitudinal – perpendicular to the direction of the pins and transverse – parallel to the direction of the pins). The heatsink kit contains four M3 x 0.5 steel mounting screws and a precut thermal interface pad for improved thermal resistance between the power module and the heatsink. The screws should be installed using a torque-limiting driver set between 0.35 and 0.55 Nm (3-5 in-lbs).

During heatsink assembly, the base-plate to heatsink interface must be carefully managed. A thermal pad may be required to reduce mechanical-assembly-related stresses and improve the thermal connection. Please contact TDK Innoveta Engineering for recommendations on this subject.

The system designer must use an accurate estimate or actual measurement of the internal airflow rate and temperature when doing the heatsink thermal analysis. For each application, a review of the heatsink fin orientation should be completed to verify proper fin alignment with airflow direction to maximize the heatsink effectiveness. With respect to TDK Innoveta standard heatsinks, contact TDK Innoveta for the latest performance data.

Operating Information:

Over-Current Protection: The power modules have current limit protection to protect the module during output overload and short circuit conditions. During overload conditions, the power modules may protect themselves by entering a hiccup current limit mode. The modules will operate normally once the output current returns to the specified operating range. There is a typical delay of 2mS from the time an overload condition appears at the module output until the hiccup mode will occur.

Output Over-Voltage Protection: The power modules have a control circuit, independent of the primary control loop that reduces the risk of over voltage appearing at the output of the power module during a fault condition. If there is a fault in the primary regulation loop, the over voltage protection circuitry will cause the power module to shut down. The module remains off unless either the input power is recycled or the on/off switch is toggled.

The iHA Veta® family also offers a hiccup over-voltage protection once it detects that the output voltage has reached the level indicated in the Electrical Data section for the power module of interest. When the condition causing the over-voltage is corrected, the module will operate normally.

Thermal Protection: When the power modules exceed the maximum operating temperature, the modules may turn-off to safeguard the power unit against thermal damage. The module will auto restart as the unit is cooled below the over temperature threshold.

Remote On/Off: - The power modules have an internal remote on/off circuit. The user must supply an open-collector or compatible switch between the Vin(-) pin and the on/off pin. The maximum voltage generated by the power module at the on/off terminal is 15V. The maximum allowable leakage current of the switch is 50uA. The switch must be capable of maintaining a low signal Von/off < 1.2V while sinking 1mA.

It is recommended that the power module be kept off for at least 100mS each time it is turned off.

The standard on/off logic is positive logic. The power module will turn on if terminal 2 is left open and will be off if terminal 2 is connected to terminal 4. An optional negative logic is available. The power module will turn on if terminal 2 is connected to terminal 4, and it will be off if terminal 2 is left open.

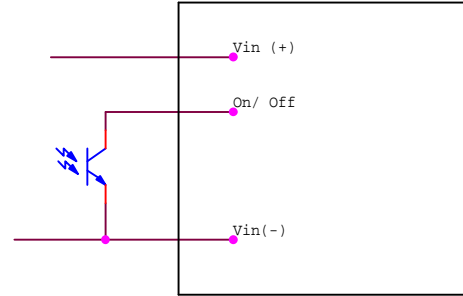

An On/Off Control Circuit

Output Voltage Adjustment: The output voltage of the power module may be adjusted by using an external resistor connected between the Vout trim terminal (pin 7) and either the Sense (+) or Sense (-) terminal. If the output voltage adjustment feature is not used, pin 7 should be left open. Care should be taken to avoid injecting noise into the power module's trim pin. A small 0.01uF capacitor between the power module's trim pin and Sense (-) pin may help avoid this.

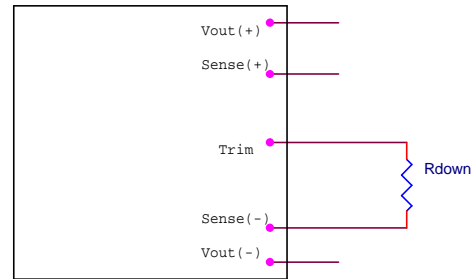

Circuit to decrease output voltage

With a resistor between the trim and Sense (-) terminals, the output voltage is adjusted down. To adjust the output voltage down a

percentage of V_{out} (% V_o) from $V_{o,nom}$, the trim resistor should be chosen according to the following equation:

$$R_{down} = \left(\frac{100\%}{\Delta_{down}} - 2 \right) \text{ k}\Omega$$

where

$$\Delta_{down} = \frac{V_{nom} - V_{desired}}{V_{nom}} \cdot 100\%$$

The current limit set point does not increase as the module is trimmed down, so the available output power is reduced.

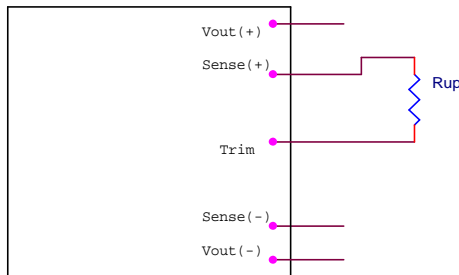

Circuit to increase output voltage

With a resistor between the trim and sense (+) terminals, the output voltage is adjusted up. To adjust the output voltage up a percentage of V_{out} (% V_o) from $V_{o,nom}$ the trim resistor should be chosen according to the following equation:

$$R_{up} = \frac{\left[\frac{V_{nom}}{V_{ref}} - 2 \right] \cdot (1 + \Delta_{up}) + 1}{\Delta_{up}} \text{ k}\Omega$$

where

$$\Delta_{up} = \frac{V_{desired} - V_{nom}}{V_{nom}} \cdot 100\% \text{ and}$$

The value of V_{ref} is found in the Electrical Data section for the power module of interest. Trim up and trim down curves are found in the Electrical Characteristics section for the power module of interest.

The maximum power available from the power module is fixed. As the output voltage is

trimmed up, the maximum output current must be decreased to maintain the maximum rated power of the module.

As the output voltage is trimmed, the output over-voltage set point is not adjusted. Trimming the output voltage too high may cause the output over voltage protection circuit to be triggered.

Remote Sense: The power modules feature remote sense to compensate for the effect of output distribution drops. The output voltage sense range defines the maximum voltage allowed between the output power terminals and output sense terminals, and it is found on the electrical data page for the power module of interest. If the remote sense feature is not being used, the Sense(+) terminal should be connected to the $V_o(+)$ terminal and the Sense (-) terminal should be connected to the $V_o(-)$ terminal. The output voltage at the $V_o(+)$ and $V_o(-)$ terminals can be increased by either the remote sense or the output voltage adjustment feature. The maximum voltage increase allowed is the larger of the remote sense range or the output voltage adjustment range; it is not the sum of both.

As the output voltage increases due to the use of the remote sense, the maximum output current must be decreased for the power module to remain below its maximum power rating.

EMC Considerations: TDK Innoveta power modules are designed for use in a wide variety of systems and applications. For assistance with designing for EMC compliance, please contact TDK Innoveta technical support.

Input Impedance: The source impedance of the power feeding the DC/DC converter module will interact with the DC/DC converter. To minimize the interaction, a 200-1000uF input electrolytic capacitor should be present.

Input/Output Ripple and Noise Measurements:

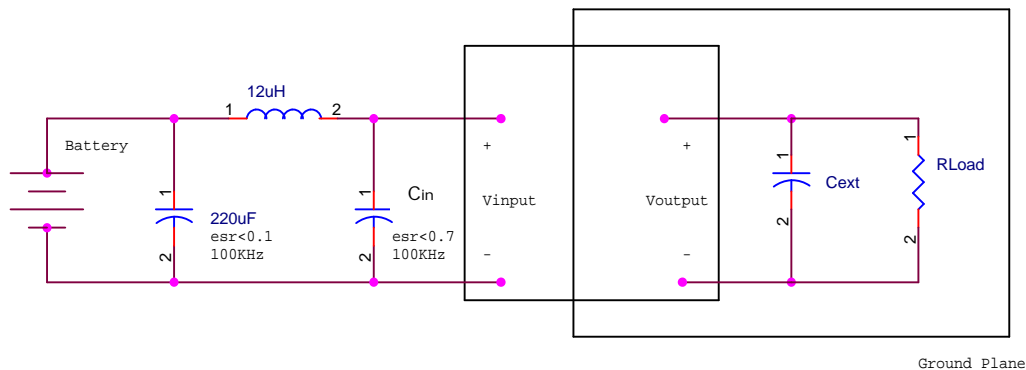

The input reflected ripple is measured with a current probe and oscilloscope. The ripple current is the current through the 12uH inductor. The capacitor Cin shall be at least 100uF/100V. One 470uF or two 220uF/100V capacitors in parallel are recommended.

The output ripple measurement is made approximately 9 cm (3.5 in.) from the power module using an oscilloscope and BNC socket. The capacitor Cext is located about 5 cm (2 in.) from the power module; its value varies from code to code and is found on the electrical data page for the power module of interest under the ripple & noise voltage specification in the Notes & Conditions column.

Safety Considerations:

All TDK Innoveta products are certified to regulatory standards by an independent, Certified Administrative Agency laboratory. UL 1950, 3rd edition (US & Canada), and other global certifications are typically obtained for each product platform.

Various safety agency approvals are pending on the iHx product family. For safety agency approval of the system in which the DC-DC power module is installed, the power module must be installed in compliance with the creepage and clearance requirements of the safety agency. The isolation is basic insulation. For applications requiring basic insulation, care must be taken to maintain minimum creepage and clearance distances when routing traces near the power module.

As part of the production process, the power modules are hi-pot tested from primary and secondary at a test voltage of 1500Vdc. The case pin is considered a primary pin for the purpose of hi-pot testing.

When the supply to the DC-DC converter is less than 60Vdc, the power module meets all of the requirements for SELV. If the input voltage is a hazardous voltage that exceeds

60Vdc, the output can be considered SELV only if the following conditions are met:

- 1) The input source is isolated from the ac mains by reinforced insulation.
- 2) The input terminal pins are not accessible.
- 3) One pole of the input and one pole of the output are grounded or both are kept floating.
- 4) Single fault testing is performed on the end system to ensure that under a single fault, hazardous voltages do not appear at the module output.

To preserve maximum flexibility, the power modules are not internally fused. An external input line normal blow fuse with the maximum rating stipulated in the Electrical Data section is required by safety agencies. A lower value fuse can be selected based upon the maximum dc input current and maximum inrush energy of the power module

Reliability:

The power modules are designed using TDK Innoveta's stringent design guidelines for component derating, product qualification, and design reviews. Early failures are screened out by both burn-in and an automated final test. The MTBF is calculated to be greater

than 2M hours using the Telcordia TR-332 calculation method.

Improper handling or cleaning processes can adversely affect the appearance, testability, and reliability of the power modules. Contact TDK Innoveta technical support for guidance regarding proper handling, cleaning, and soldering of TDK Innoveta's power modules.

Quality:

TDK Innoveta's product development process incorporates advanced quality planning tools such as FMEA and Cpk analysis to ensure designs are robust and reliable. All products

are assembled at ISO certified assembly plants.

Warranty:

TDK Innoveta's comprehensive line of power solutions includes efficient, high-density DC-DC converters. TDK Innoveta offers a three-year limited warranty. Complete warranty information is listed on our web site or is available upon request from TDK Innoveta.

TDK Innoveta Inc

3320 Matrix Drive, Suite 100
Richardson, Texas 75082

Phone (877) 498-0099 Toll Free
(469) 916-4747

Fax (877) 498-0143 Toll Free
(214) 239-3101

support@tdkinnoveta.com
<http://www.tdkinnoveta.com/>

Information furnished by TDK Innoveta is believed to be accurate and reliable. However, TDK Innoveta assumes no responsibility for its use, nor for any infringement of patents or other rights of third parties, which may result from its use. No license is granted by implication or otherwise under any patent or patent rights of TDK Innoveta. TDK Innoveta components are not designed to be used in applications, such as life support systems, wherein failure or malfunction could result in injury or death. All sales are subject to TDK Innoveta's Terms and Conditions of Sale, which are available upon request. Specifications are subject to change without notice. TDK logo is a trademark or registered trademark of TDK Corporation.