

## iCG Series DC/DC Power Modules 4.5-14V Input, 6A Output Surface Mount Power Module



iCG power modules perform local voltage conversion from either a 5V or 12V bus. The iCG12006A007V utilizes a low component count that results in both a low cost structure and a high level of performance. The open-frame, compact, surface mountable design features a low profile and weight as well as additional edge plated pads that allow for extremely flexible and robust manufacturing processes.

### Features

- Size – 12.2mm x 12.2 mm x 8.5 mm (0.48 in. x 0.48 in. x 0.335 in.)
- DOSA Compatible Footprint
- Edge plated castellations for forming inspectable solder joints
- Surface mountable
- Maximum weight 3g (0.106 oz)
- Up to 33W of output power in high ambient temperature, low airflow environments with no power derating
- Positive logic on/off
- Flexible Output Voltage Sequencing
- Starts with pre-biased output
- Output voltage adjustment – industry standard
- Outstanding transient response without the need for external loop tuning components
- Constant switching frequency
- Remote Sense
- Power Good
- Full, auto-recovery protection:
  - Input under voltage
  - Short circuit
  - Thermal limit
- ISO Certified manufacturing facilities
- Patent pending

### Optional Features

- Negative logic on/off
- No output voltage sequencing
- Solder bumping for enhanced solderability on the EPC footprint



## Advance Data Sheet: iCG Series – Non-isolated SMT Power Module

### Ordering information:

Product Identifier	Package Size	Platform	Input Voltage	Output Current/Power	Units	Main Output Voltage	# of Outputs		Safety Class	Feature Set		RoHS Indicator
i	C	G	12	006	A	007	V	-	0	06	-	R
TDK Innoveta	12.19 mm x 12.19 mm	iCG	4.5V to 14V	6	Amps	0.70V to 5.5V	Single			See option table		R=RoHS 6 Compliant

### Option Table:

Feature Set	Positive Logic On/Off	Negative Logic On/Off	Sequence	LGA Solder Bumping*	EPC Solder Bumping*	Product Label Marking
00	X		X		x	-000
01		X	X		x	-001
02	X				x	-002
03		X			x	-003
04	X		X	x		-004
05		X	X	x		-005
06	X			x		-006
07		X		x		-007

\* LGA solder bumping option is recommended for customers using the DOSA standard land grid array footprint and EPC soldering bumping is recommended for customers using the inspectable edge plated castellations pads

### Product Offering:

Code	Input Voltage	Output Voltage	Output Current	Maximum Output Power	Efficiency
iCG12006A007V	4.5V-14V	0.70V-5.5V	6A	33W	94%



3320 Matrix Drive, Suite 100  
 Richardson, TX 75802  
 Phone (877) 498-0099 Toll Free  
 (469) 916-4747  
 Fax (877) 498-0143 Toll Free  
 (214) 239-3101  
[support@tdkinnoveta.com](mailto:support@tdkinnoveta.com)  
<http://www.tdkinnoveta.com/>

## Mechanical Specification:

Dimensions are in mm [in]. Unless otherwise specified tolerances are:  $x.x \pm 0.5$  [0.02],  $x.xx \pm 0.25$  [0.010]

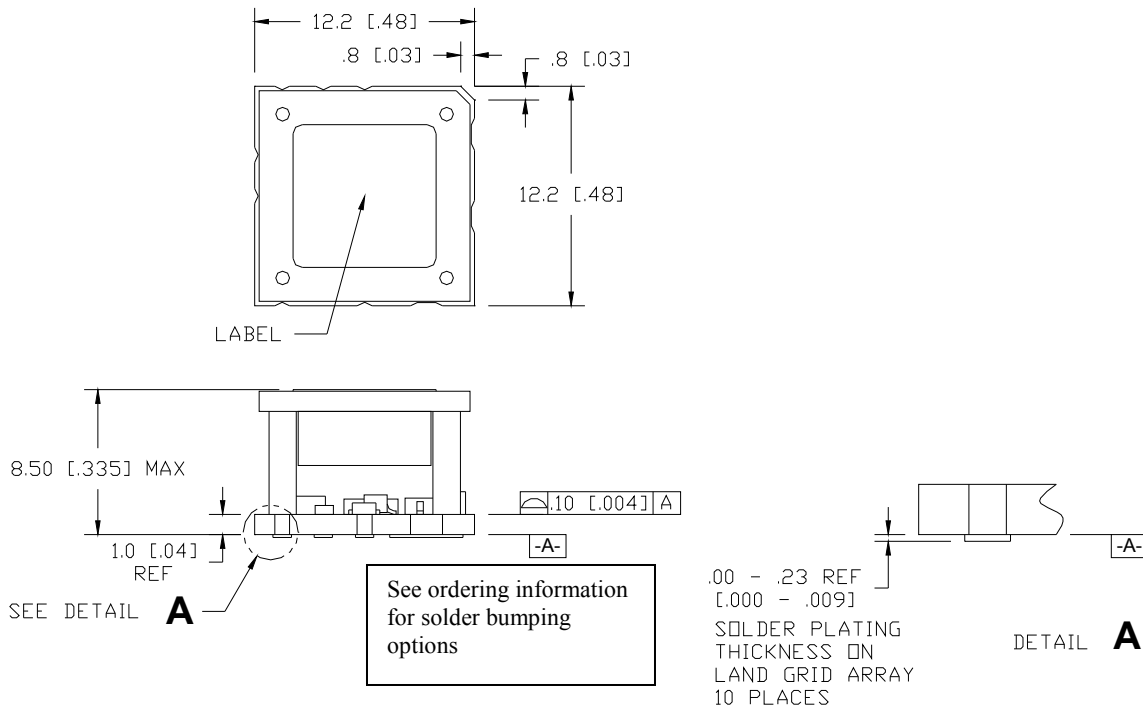

## Pin Locations: (bottom view)

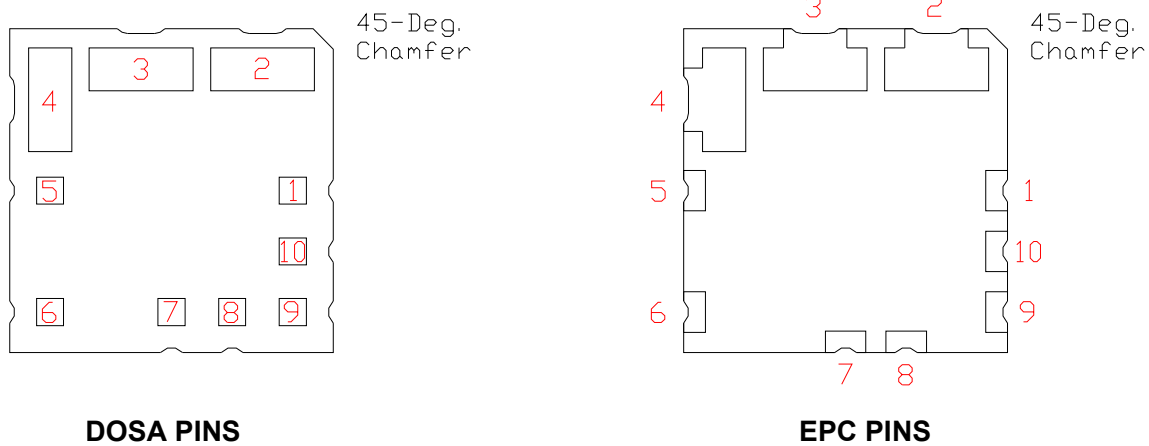

## Pin Assignment:

PIN	FUNCTION	PIN	FUNCTION
1	ON/OFF	6	TRIM
2	VIN	7	GND
3	GND	8	NC
4	VOU	9	SEQ
5	SENSE	10	PW GOOD

## Recommended Footprint (top view):

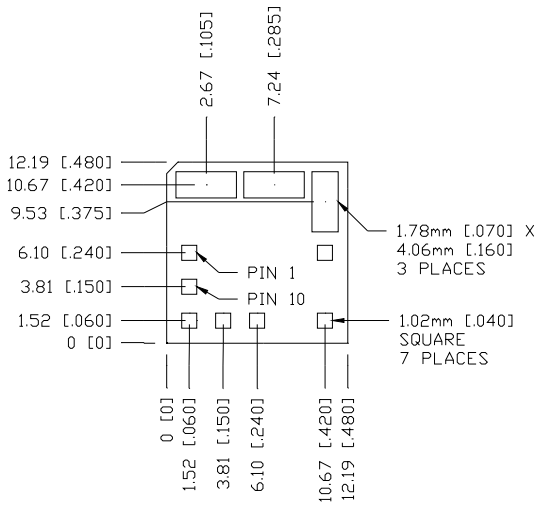

**FOR DOSA STANDARD PADS**

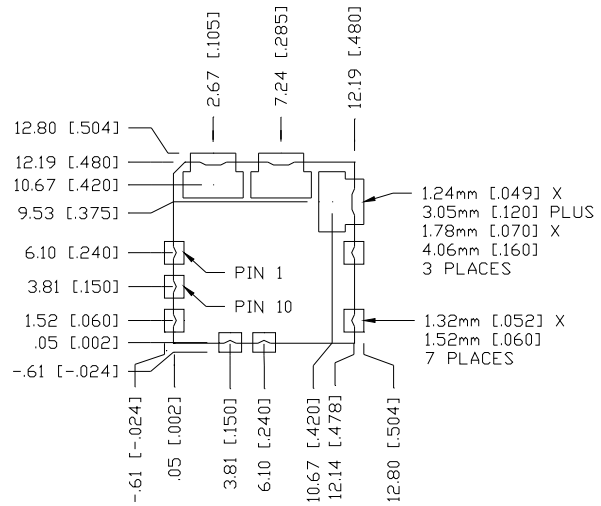

**FOR EPC PADS**

## Advance Data Sheet: iCG Series – Non-isolated SMT Power Module

### Absolute Maximum Ratings:

Stress in excess of Absolute Maximum Ratings may cause permanent damage to the device.

Characteristic	Min	Max	Unit	Notes & Conditions
Continuous Input Voltage	-0.25	15	Vdc	
Storage Temperature	-55	125	°C	
Operating Temperature Range (Tc)	-40	115*	°C	Measured at the location specified in the thermal measurement figure; maximum temperature varies with output current – see curve in the thermal performance section of the data sheet.

\* Engineering estimate

### Input Characteristics:

Unless otherwise specified, specifications apply over all rated Input Voltage, Resistive Load, and Temperature conditions.

Characteristic	Min	Typ	Max	Unit	Notes & Conditions
Operating Input Voltage	4.5	---	14	Vdc	
Maximum Input Current	---	---	6.5	A	Vin=2.4 to Vin,max; Io=Io,max
Startup Delay Time from application of input voltage	---	5	---	mS	Vo=0 to 0.1*Vo,set; on/off=on, Io=Io,max, Tc=25°C
Startup Delay Time from on/off	---	5	---	mS	Vo=0 to 0.1*Vo,set; Vin=Vi,nom, Io=Io,max, Tc=25°C
Output Voltage Rise Time	---	4	---	mS	Io=Io,max, Tc=25°C, Vo=0.1 to 0.9*Vo,set
Input Reflected Ripple	---	30*	---	mApp	See input/output ripple measurement figure; BW=20 MHz
Input Ripple Rejection	---	40*	---	dB	@ 120 Hz
Turn on input voltage	---	4.2	---	V	
Turn off input voltage	---	3.5	---	V	

\*Engineering Estimate

Caution: The power modules are not internally fused. An external input line normal blow fuse with a maximum value of 10A is required, see the Safety Considerations section of the data sheet.

## Advance Data Sheet: iCG Series – Non-isolated SMT Power Module

### Electrical Data:

Characteristic	Min	Typ	Max	Unit	Notes & Conditions
Output Voltage Initial Setpoint	-2	-	+2	%	Vo=3.3Vsetting, Vin=Vin,nom; Io=Io,max; Tc = 25°C
Output Voltage Tolerance	-3	-	+3	%	Over all rated input voltage, load, and temperature conditions to end of life
Efficiency					
Vo = 1.2V	---	84	---	%	Vin=5V; Io=Io,max; Tc=25°C
Vo = 1.5V	---	86	---	%	
Vo = 1.8V	---	88	---	%	
Vo = 3.3V	---	92	---	%	
Vo = 5.0V	---	94	---	%	
Line Regulation	---	3	---	mV	Vin=Vin,min to Vin,max
Load Regulation	---	6	---	mV	Io=Io,min to Io,max
Output Current	0	---	6	A	
Output Current Limiting Threshold	---	10	---	A	Vo = 0.9*Vo,nom, Tc<Tc,max)
Short Circuit Current	---	0.5	---	A	Vo = 0.25V, Tc = 25°C
Output Ripple and Noise Voltage	---	15	---	mVpp	Measured across one 0.1 uF ceramic capacitor and two 22uF ceramic capacitor – see input/output ripple measurement figure; BW = 20MHz.
Output Voltage Adjustment Range	0.7	---	5.5	V	
Output Voltage Sense Range	---	---	0.5	V	
Dynamic Response: Recovery Time	---	25	---	uS	di/dt =10A/uS, Vin=Vin,nom; Vo=1.5V, load step from 25% to 75% of Io,max
Transient Voltage	---	140	---	mV	
Switching Frequency	---	600	---	kHz	Fixed
External Load Capacitance	47	---	1000*	uF	
Vref		0.59		V	Required for trim calculation
F		10000		Ω	Required for trim calculation

\*Please contact TDK Innoveta for technical support for very low esr capacitor banks or if higher capacitance is required

**Electrical Characteristics:**

**Typical Efficiency vs. Input Voltage**

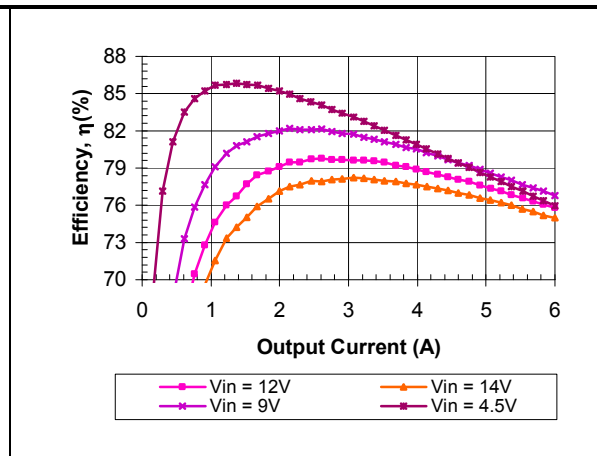
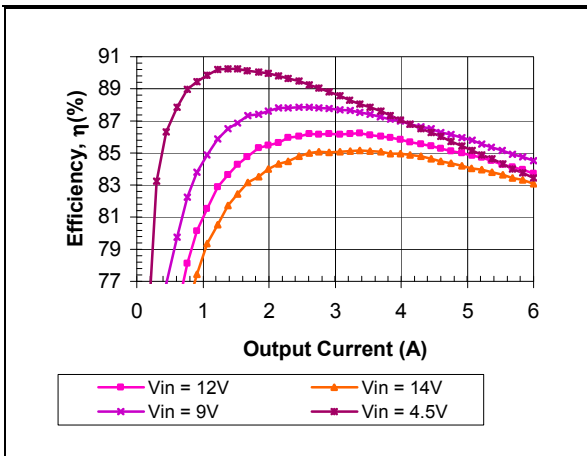
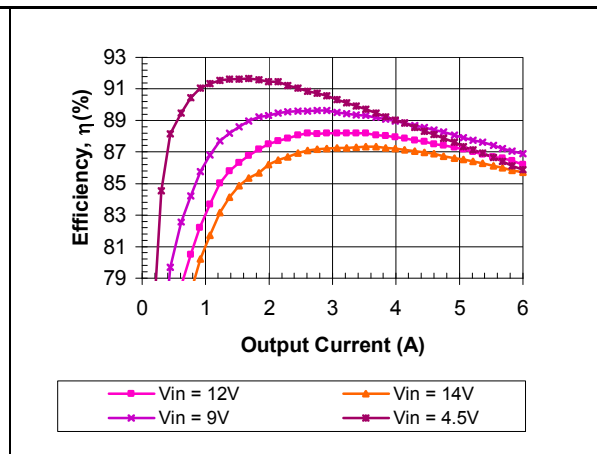
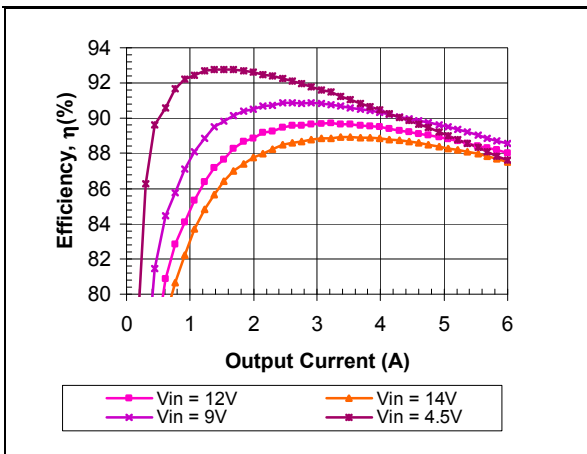
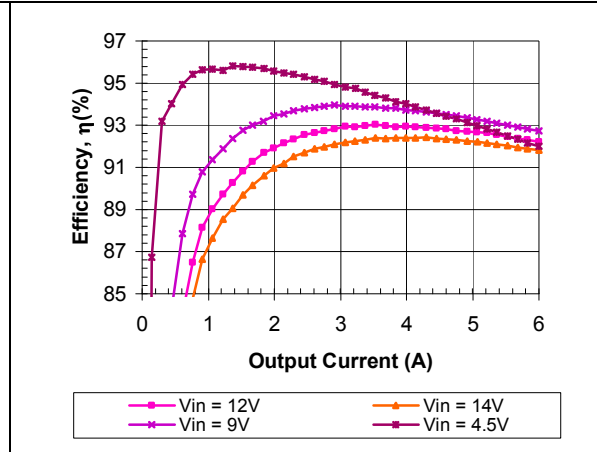
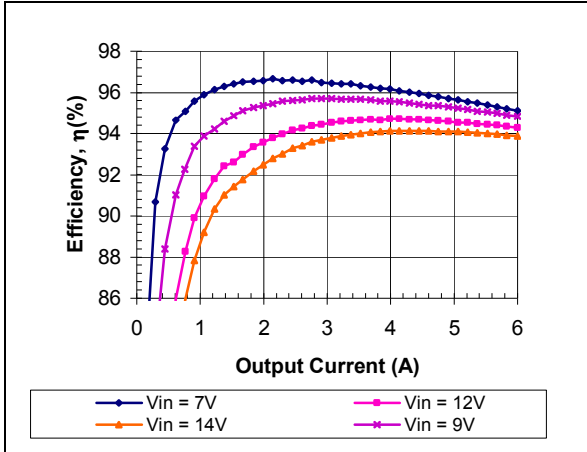

**Electrical Characteristics:**

**Typical Power Dissipation vs. Input Voltage**

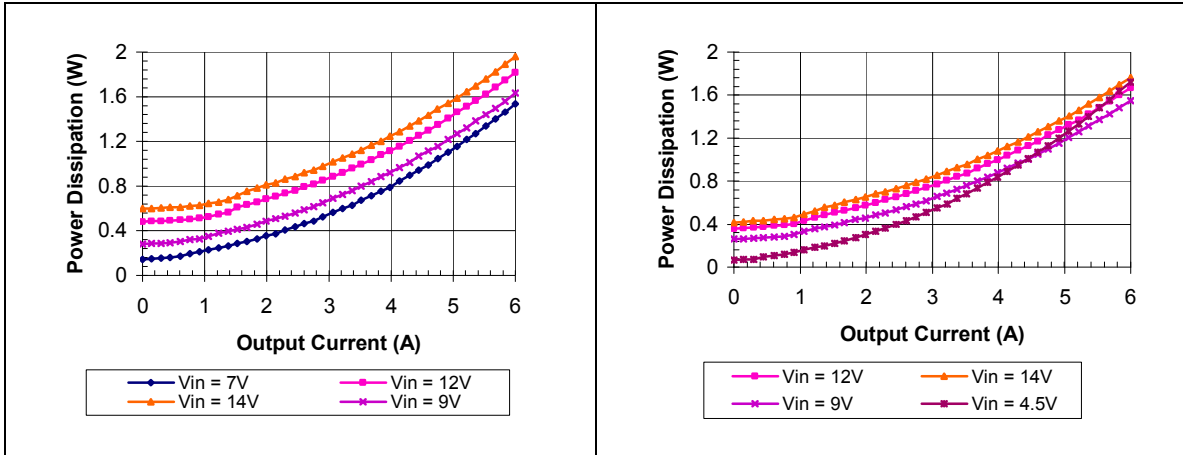

Vo = 5V

Vo = 3.3V

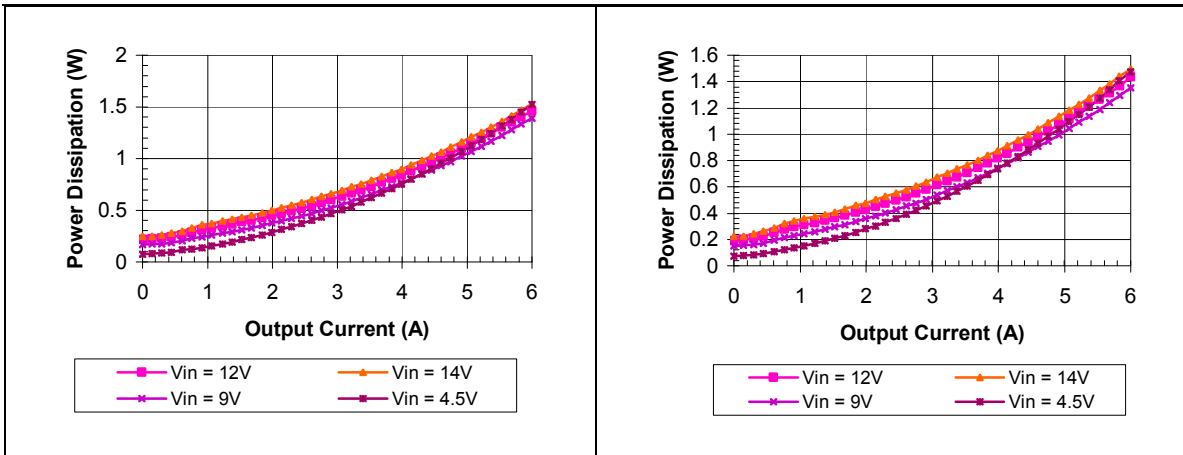

Vo = 1.8V

Vo = 1.5V

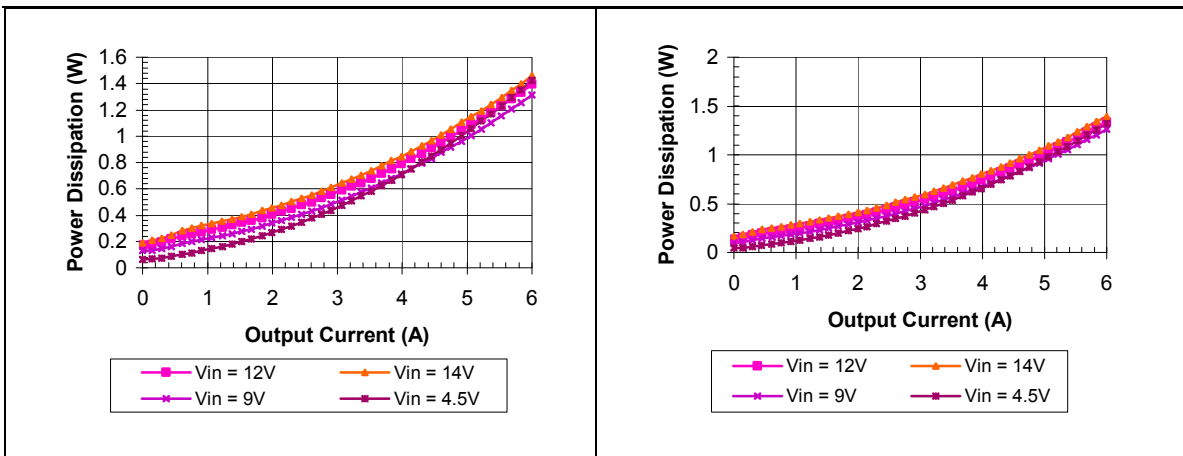

Vo = 1.2V

Vo = 0.7V

## Electrical Characteristics:

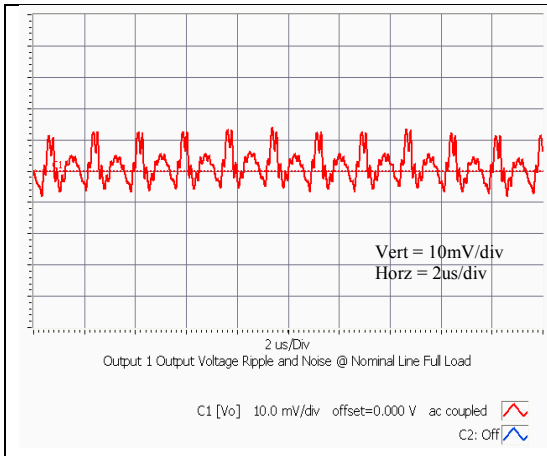

Vo=1.8V Typical Output Ripple at nominal Input voltage and full load at Ta=25 degrees

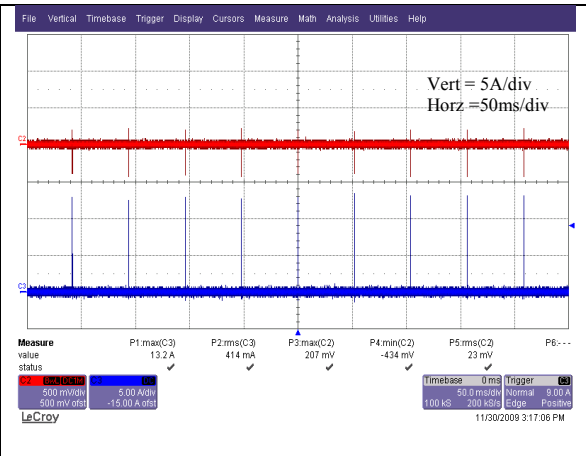

Typical Output Short Circuit Current – CH3, blue

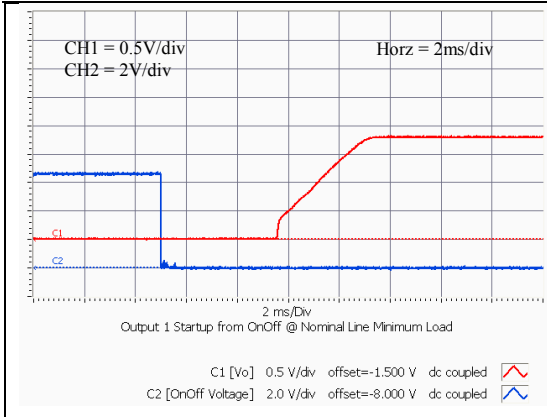

Vo=1.8V Typical startup characteristic from on/off at light load. Upper trace - output voltage, lower trace – on/off signal

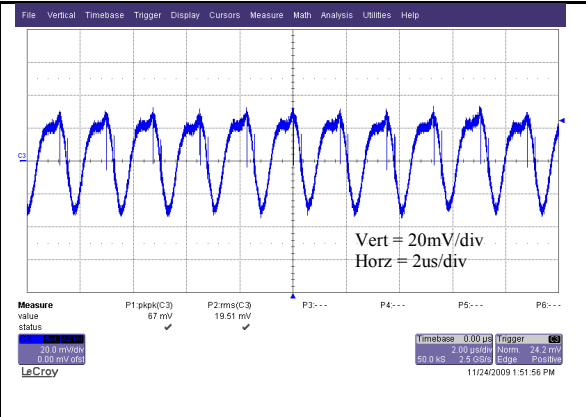

Vo=1.8V Typical Input Ripple at nominal Input Voltage and full load at Ta=25 degrees. Input capacitors 2 x 22uF ceramic

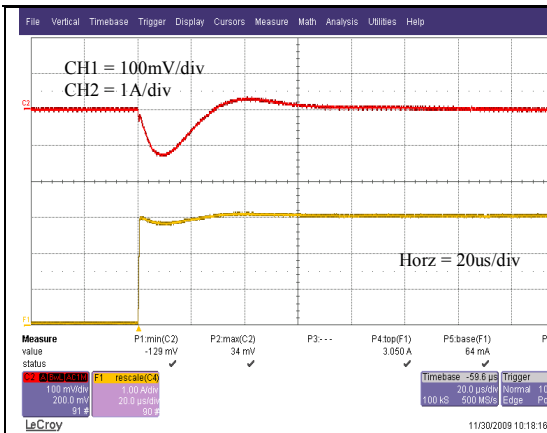

Vo=1.8V Typical output voltage transient response to load step from 25% to 75% of full load with output current slew rate of 10A/uS. (Cext = 1x100uF ceramic capacitor)

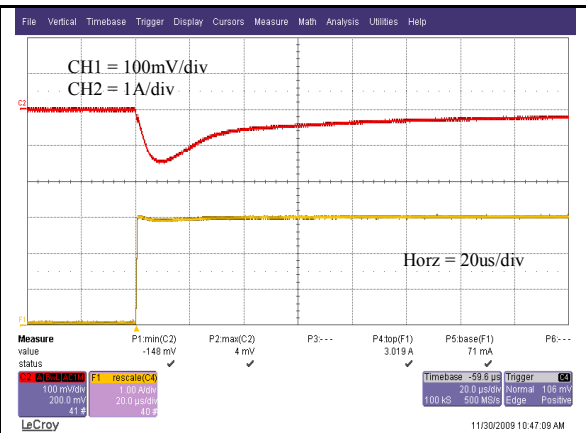

Vo=3.3V Typical output voltage transient response to load step from 0% to 50% of full load with output current slew rate of 10A/uS. (Cext = 1x100uF ceramic capacitor)

**Electrical Characteristics (continued):**

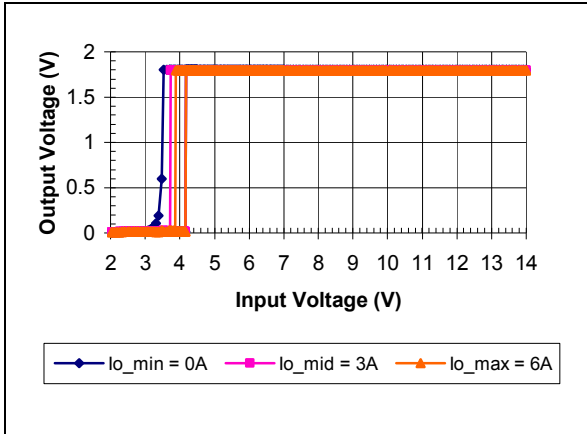

Vo=1.8V Typical Output Voltage vs. Input Voltage Characteristics

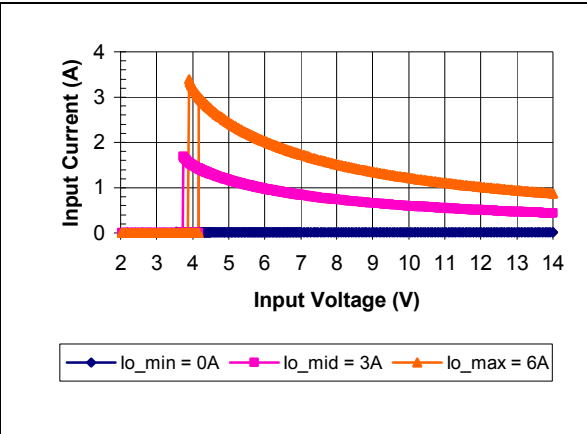

Vo=1.8V Typical Input Current vs. Input Voltage Characteristics

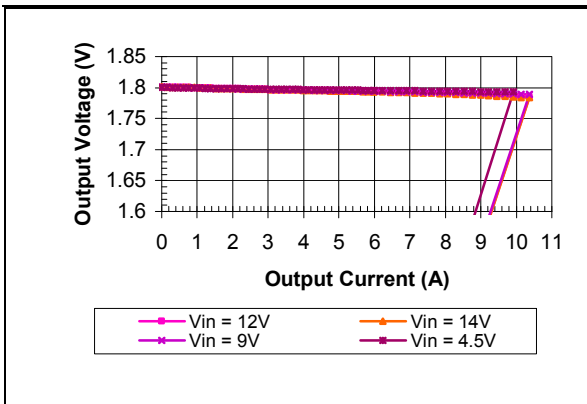

Vo=1.8V Typical Current Limit Characteristics

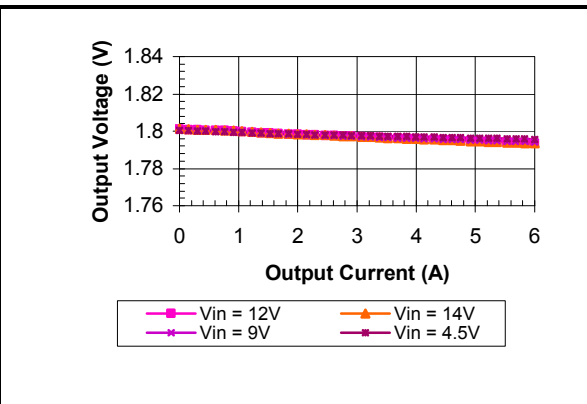

Vo=1.8V Typical load regulation

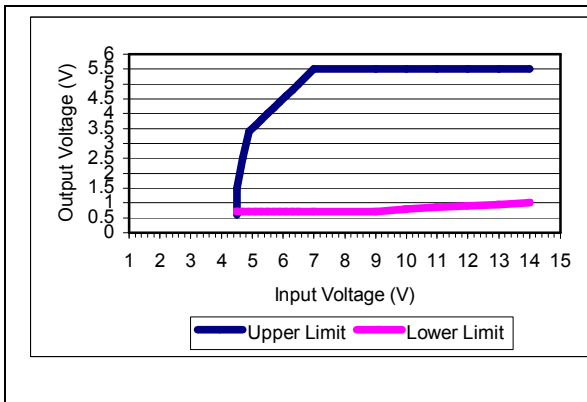

Output Voltage versus Input Voltage Operating Range

**Thermal Performance:**

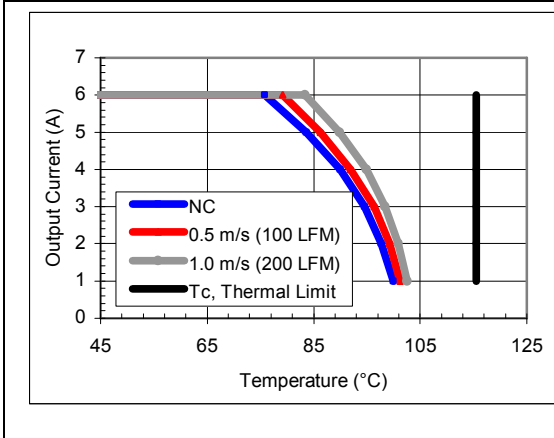

-Vo=5.5V, Vin=12V maximum output current vs. ambient temperature at nominal input voltage for natural convection (60lfm) with airflow from pin 3 to pin 7.

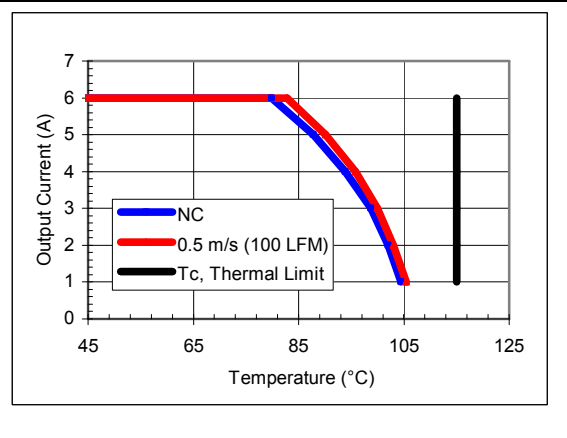

Vo=3.3V, Vin=12V maximum output current vs. ambient temperature at nominal input voltage for natural convection (60lfm) with airflow from pin 3 to pin 7.

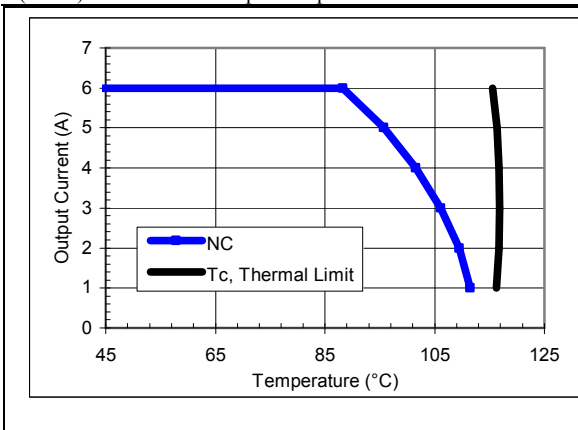

Vo=0.7V, Vin=12V maximum output current vs. ambient temperature at nominal input voltage for natural convection (60lfm) with airflow from pin 3 to pin 7.

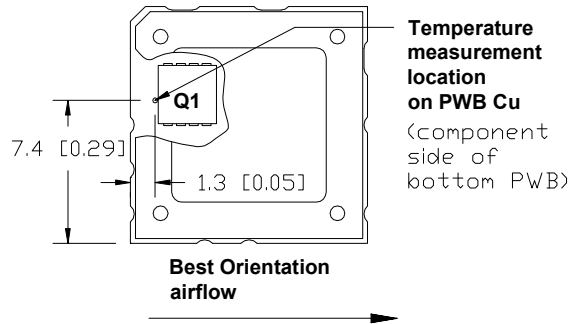

iCG12006A007V thermal measurement location – top view

The thermal curves provided are based upon measurements made in TDK Innoveta's experimental test setup that is described in the Thermal Management section. Due to the large number of variables in system design, TDK Innoveta recommends that the user verify the module's thermal performance in the end application. The critical component should be thermo coupled and monitored, and should not exceed the temperature limit specified in the derating curve above. It is critical that the thermocouple be mounted in a manner that gives direct thermal contact or significant measurement errors may result. TDK Innoveta can provide modules with a thermocouple pre-mounted to the critical component for system verification tests.

## Soldering Information:

iCG surface mountable power modules are intended to be compatible with standard surface mount component soldering processes and either hand placed or automatically picked and placed. The figure below shows the position for vacuum pick up. The maximum weight of the power module is 3g (0.106 oz.). Improper handling or cleaning processes can adversely affect the appearance, testability, and reliability of the power modules. The iCG product is a moisture sensitivity level 2 device. Contact TDK Innoveta technical support for guidance regarding proper handling, cleaning, and soldering of TDK Innoveta's power modules.

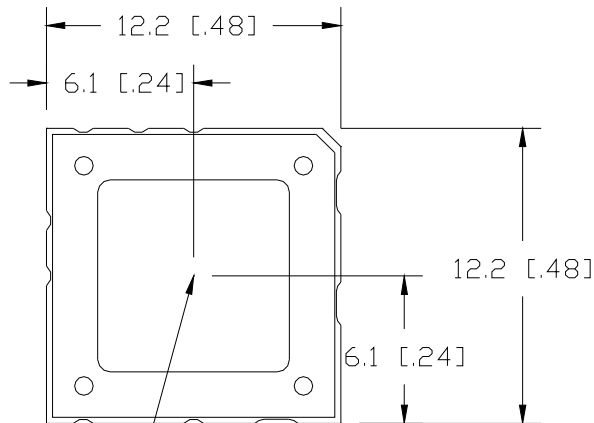

PICK AND PLACE TARGET  
(NO SYMBOL ON LABEL)

## Reflow Soldering

The iCG platform is an open frame power module manufactured with SMT (surface mount technology). Due to the high thermal mass of the power module and sensitivity to heat of some SMT components, extra caution should be taken when reflow soldering. Failure to follow the reflow soldering guidelines described below may result in permanent damage and/or affect performance of the power modules.

The iCG power modules can be soldered using natural convection, forced convection, IR (radiant infrared), and convection/IR reflow technologies. The module should be thermally characterized in its application to develop a temperature profile. Thermal couples should be mounted to terminal 3 and terminal 6 and be monitored. The temperatures should be maintained below 260 degrees. Oven temperature and conveyer belt speeds should be controlled to ensure these limits are not exceeded. In most manufacturing processes, the solder paste required to form a reliable connection can be applied with a standard 6 mil stencil.

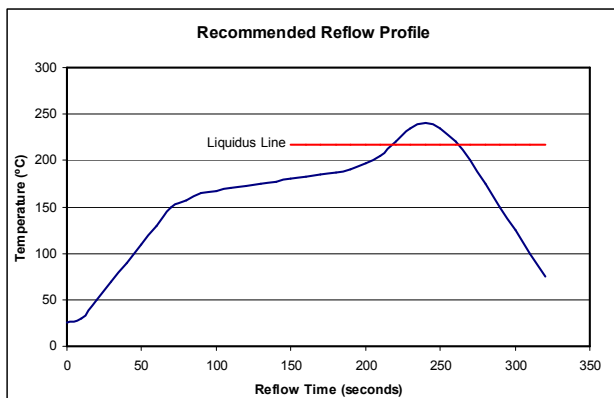

iCG Power Module suggested reflow-soldering profile

## Thermal Management:

An important part of the overall system design process is thermal management; thermal design must be considered at all levels to ensure good reliability and lifetime of the final system. Superior thermal design and the ability to operate in severe application environments are key elements of a robust, reliable power module.

A finite amount of heat must be dissipated from the power module to the surrounding environment. This heat is transferred by the three modes of heat transfer: convection, conduction and radiation. While all three modes of heat transfer are present in every application, convection is the dominant mode of heat transfer in most applications. However, to ensure adequate cooling and proper operation, all three modes should be considered in a final system configuration.

The open frame design of the power module provides an air path to individual components. This air path improves convection cooling to the surrounding environment, which reduces areas of heat concentration and resulting hot spots.

**Test Setup:** The thermal performance data of the power module is based upon measurements obtained from a wind tunnel test with the setup shown in the wind tunnel figure. This thermal test setup replicates the typical thermal environments encountered in most modern electronic systems with distributed power architectures. The electronic equipment in networking, telecom, wireless, and advanced computer systems operates in similar environments and utilizes vertically mounted PCBs or circuit cards in cabinet racks.

The power module, as shown in the figure, is mounted on a printed circuit board (PCB) and is vertically oriented within the wind tunnel. The cross section of the airflow passage is rectangular. The spacing between the top of the module and a parallel facing PCB is kept at a constant (0.5 in). The power module's orientation with respect to the airflow direction can have a significant impact on the module's thermal performance.

**Thermal Derating:** For proper application of the power module in a given thermal environment, output current derating curves are provided as a design guideline on the Thermal Performance section for the

power module of interest. The module temperature should be measured in the final system configuration to ensure proper thermal management of the power module. For thermal performance verification, the module temperature should be measured at the component indicated in the thermal measurement location figure on the thermal performance page for the power module of interest. In all conditions, the power module should be operated below the maximum operating temperature shown on the derating curve. For improved design margins and enhanced system reliability, the power module may be operated at temperatures below the maximum rated operating temperature.

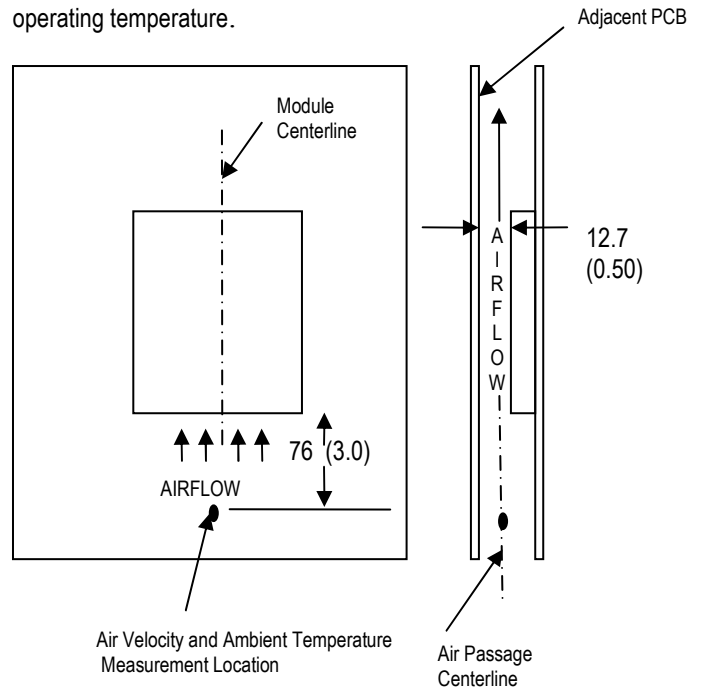

**Wind Tunnel Test Setup Figure** Dimensions are in millimeters and (inches).

Heat transfer by convection can be enhanced by increasing the airflow rate that the power module experiences. The maximum output current of the power module is a function of ambient temperature ( $T_{AMB}$ ) and airflow rate as shown in the thermal performance figures on the thermal performance page for the power module of interest. The curves in the figures are shown for natural convection through 2 m/s (400 ft/min). The data for the natural convection condition has been collected at 0.3 m/s (60 ft/min) of airflow, which is the typical airflow generated by other heat dissipating components in many of the systems that these types of modules are used in. In the final system configurations, the airflow rate for the natural convection condition can vary due to temperature gradients from other heat dissipating components.

## Operating Information:

**Over-Current Protection:** The power modules have short circuit protection to protect the module during severe overload conditions. During overload conditions, the power modules may protect themselves by entering a hiccup current limit mode. The modules will operate normally once the output current returns to the specified operating range.

**Remote On/Off:** - The power modules have an internal remote on/off circuit. The user must supply compatible switch between the GND pin and the on/off pin. The maximum voltage generated by the power module at the on/off terminal is  $V_{in,max}$ . The maximum allowable leakage current of the switch is 10uA. The switch must be capable of maintaining a low signal  $V_{on/off} < 0.5V$  while sinking 1mA.

The standard on/off logic is positive logic. In the circuit configuration shown the power module will turn off if the external switch is on and it will be on if the switch is off and the on/off pin is pulled up to  $V_{in}$  by an external 20K ohm resistor. If the positive logic feature is not being used, terminal 1 should be left open.

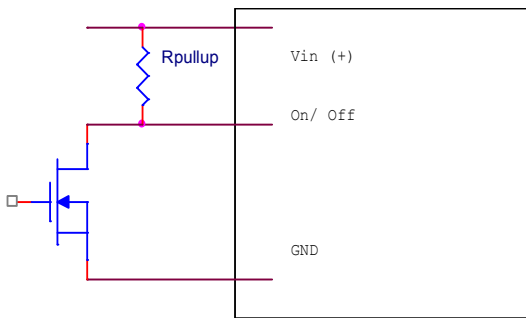

**On/Off Circuit for positive logic**

An optional negative logic is available. In the circuit configuration shown the power module will turn on if the external switch is on and it will be off if the on/off pin is pulled up to  $V_{in}$  by an external 20K ohm resistor. If the negative logic feature is not being used, terminal 1 should be left open.

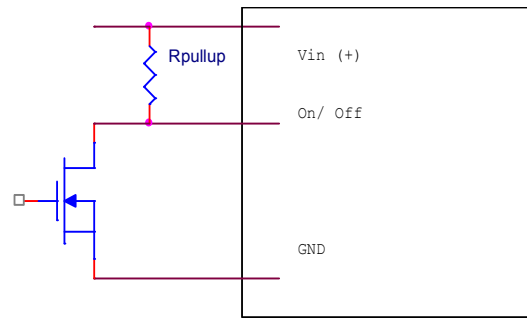

**On/Off Circuit for negative logic**

**Remote Sense:** The power modules feature remote sense to compensate for the effect of output distribution drops. The output voltage sense range defines the maximum voltage allowed between the output power terminals and output sense terminals, and it is found on the electrical data page for the power module of interest. If the remote sense feature is not being used, the Sense terminal should be connected to the  $V_o$  terminal.

The output voltage at the  $V_o$  terminal can be increased by either the remote sense or the output voltage adjustment feature. The maximum voltage increase allowed is the larger of the remote sense range or the output voltage adjustment range; it is not the sum of both. As the output voltage increases due to the use of the remote sense, the maximum output current may need to be decreased for the power module to remain below its maximum power rating.

**Power Good:** The power module features an open-drain power good signal which indicates if the output voltage is being regulated. When power is applied to the module, but the output voltage is more than +/- 12% from the nominal voltage set point due to input under voltage, over temperature, over load, or loss of control the power good will be pulled to ground through a 50 ohm maximum impedance. The maximum leakage current of the power good pin is 15uA. The voltage on the power good pin should be limited to less than 5.5V in all cases. If the power good feature is not used, the pin should be left open.

**Output Voltage Adjustment:** The output voltage of the power module may be adjusted by using an external resistor connected between the  $V_{out}$  trim terminal and GND terminal. If the output voltage adjustment feature is not used, trim terminal should be left open. Care should be taken to avoid injecting noise into the power module's trim pin. A small 0.01uF capacitor between the power module's trim pin and GND pin may help avoid this.

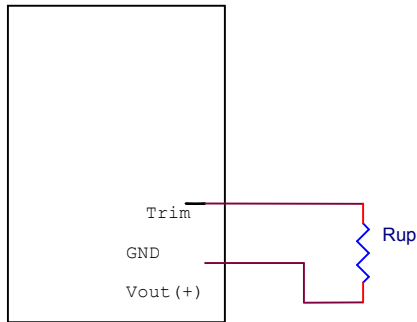

### Circuit to increase output voltage

With a resistor between the trim and GND terminals, the output voltage is adjusted up. To adjust the output voltage from  $V_{o,nom}$  to  $V_{o,up}$  the trim resistor should be chosen according to the following equation:

$$R_u := \left[ \frac{(V_{ref} \cdot F)}{(V_{oup} - V_{onom})} \right] \text{ohm}$$

The values of  $V_{ref}$  and  $F$  are found in the electrical data section for the power module of interest. The maximum power available from the power module is fixed. As the output voltage is trimmed up, the maximum output current must be decreased to maintain the maximum rated power of the module.

e.g.  $V_o = 1.8V$

$$R_u := \left[ \frac{0.59 \cdot 10000}{(1.8 - 0.59)} \right]$$

Vout (V)	Ru (Kohm)
0.7	53.6
1.2	9.67
1.5	6.48
1.8	4.88
2.5	3.09
3.3	2.18
5.0	1.34

### Voltage Sequencing:

Some iCG power modules include a voltage sequence feature. The voltage sequence feature enables the user to implement various types of power up and power down sequencing schemes including sequential startup, ratiometric startup, and simultaneous startup. If the sequencing feature is not being used the pin should be left open or tied to  $V_{in}$ . When the voltage sequencing feature is used the pre-bias immunity feature is disabled.

To use the voltage sequence feature, the module should be set to an On state using the on/off feature. The input voltage should be applied and in the specified operating range for 10mS during which a 50mV voltage potential should be maintained on the sequence pin. After the 10mS interval, an analog voltage can be applied to the sequence pin and the module's output will track the applied voltage on a one to one basis until the output reaches its set point voltage. The final sequence voltage must be higher than the module set point. For sequential shut down, the sequence pin voltage should be lowered. The module will decrease its output voltage on a one to one basis.

The voltage sequencing circuit has a brief internal response time between the voltage appearing on the sequence pin and impacting the output voltage. If necessary, the impact of the time delay can be minimized by limiting the slew rate of the voltage on the sequence pin to less than 0.5 V/ms.

For additional assistance using the voltage sequencing function, please contact TDK Innoveta technical support.

**EMC Considerations:** TDK Innoveta power modules are designed for use in a wide variety of systems and applications. For assistance with designing for EMC compliance, please contact TDK Innoveta technical support.

### Input Impedance:

The source impedance of the power feeding the DC/DC converter module will interact with the DC/DC converter. To minimize the interaction, low-esr capacitors should be located at the input to the module. It is recommended that a 22uF ceramic input capacitor be placed as close as possible to the module. Data is provided on the electrical characteristics page, showing the typical input ripple voltage with two 22uF ceramic capacitors (TDK part C3225X7R1C226MT).

## Reliability:

The power modules are designed using TDK Innoveta's stringent design guidelines for component derating, product qualification, and design reviews. The MTBF is calculated to be greater than 15M hours at full output power and  $T_a = 40^\circ\text{C}$  using the Telcordia SR-332 calculation method.

## Quality:

TDK Innoveta's product development process incorporates advanced quality planning tools such as FMEA and Cpk analysis to ensure designs are robust and reliable. All products are assembled at ISO certified assembly plants.

## Input/Output Ripple and Noise Measurements:

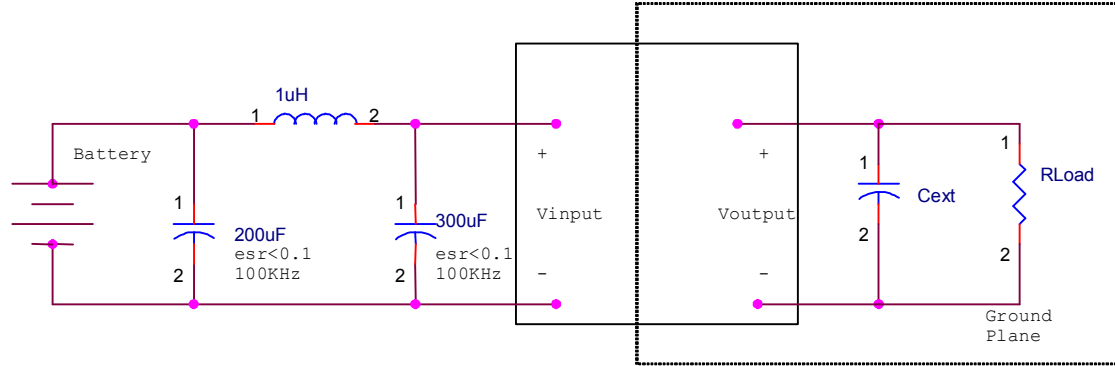

The input reflected ripple is measured with a current probe and oscilloscope. The ripple current is the current through the 1uH inductor.

The output ripple measurement is made approximately 9 cm (3.5 in.) from the power module using an oscilloscope and BNC socket. The capacitor  $C_{ext}$  is located about 5 cm (2 in.) from the power module; its value varies from code to code and is found on the electrical data page for the power module of interest under the ripple & noise voltage specification in the Notes & Conditions column.

## Safety Considerations:

As of the publishing date, certain safety agency approvals may have been received on the iCG series and others may still be pending. Check with TDK Innoveta for the latest status of safety approvals on the iCG product line.

For safety agency approval of the system in which the DC-DC power module is installed, the power module must be installed in compliance with the creepage and clearance requirements of the safety agency.

To preserve maximum flexibility, the power modules are not internally fused. An external input line normal blow fuse with a maximum value of 10A is required by safety agencies. A lower value fuse can be selected based upon the maximum dc input current and maximum inrush energy of the power module.

## Warranty:

TDK Innoveta's comprehensive line of power solutions includes efficient, high-density DC-DC converters. TDK Innoveta offers a three-year limited warranty. Complete warranty information is listed on our web site or is available upon request from TDK Innoveta.



3320 Matrix Drive, Suite 100  
Richardson, TX 75802  
Phone (877) 498-0099 Toll Free  
(469) 916-4747  
Fax (877) 498-0143 Toll Free  
(214) 239-3101

[support@tdkinnoveta.com](mailto:support@tdkinnoveta.com)  
<http://www.tdkinnoveta.com/>

Information furnished by TDK Innoveta is believed to be accurate and reliable. However, TDK Innoveta assumes no responsibility for its use, nor for any infringement of patents or other rights of third parties, which may result from its use. No license is granted by implication or otherwise under any patent or patent rights of TDK Innoveta. TDK Innoveta components are not designed to be used in applications, such as life support systems, wherein failure or malfunction could result in injury or death. All sales are subject to TDK Innoveta's Terms and Conditions of Sale, which are available upon request. Specifications are subject to change.