



Datasheet DC-DC Power Modules Xeta® iHG Half Brick 48V Input, 1.5V/80A Output

TDK Innoveta Inc.

3320 Matrix Drive, Suite 100
Plano, Texas 75082

Phone (877) 498-0099 Toll Free
(469) 916-4747
Fax (877) 498-0143 Toll Free
(214) 239-3101

support@tdkinnoveta.com
<http://www.tdkinnoveta.com/>

Information furnished by TDK Innoveta is believed to be accurate and reliable. However, TDK Innoveta assumes no responsibility for its use, nor for any infringement of patents or other rights of third parties, which may result from its use. No license is granted by implication or otherwise under any patent or patent rights of TDK Innoveta. TDK Innoveta components are not designed to be used in applications, such as life support systems, wherein failure or malfunction could result in injury or death. All sales are subject to TDK Innoveta's Terms and Conditions of Sale, which are available upon request. Specifications are subject to change without notice.

Platform Overview:

Xeta® iHG48 Series DC-DC Power Modules 48V Input, 1.5V / 80A Output Half-Brick

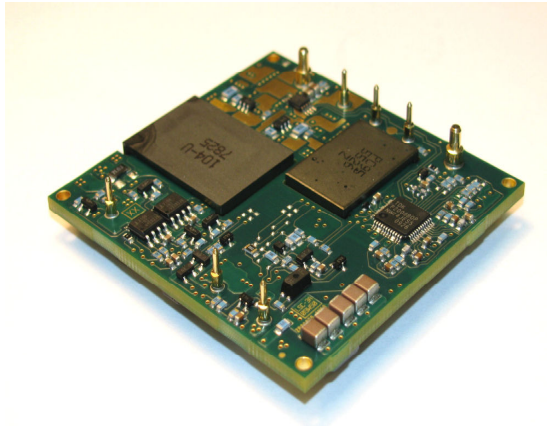

The Xeta® iHG48 Series power modules operate over a wide 36 – 75Vdc input voltage range and provide one regulated dc output voltage that is electrically isolated from the input. The single board open-frame type design with high conversion efficiency (up to 89%), and superior thermal performance make iHG series modules ideally suited for high power, low air flow telecom applications in demanding thermal environments. A wide output voltage trim range, -50 to 10%, and remote sensing are standard features enhancing versatility.

Standard Features:

- **RoHS compliant**
- Standard Half Brick footprint
- Optimized output power: 120W
- Full load efficiency, 83.5% typical
- 75% load (60A) efficiency: 86%
- Wide output trim voltage range
- Up to 80A of true usable current
- Single board open-frame design
62A at 65C, 200LFM
- Monotonic start-up into a pre-biased output bus
- Remote sense
- Basic insulation – 1500 Vdc
- Constant switching frequency
- Auto-recovery protection:
 - Input UV protection
 - Output over voltage
 - Output over current
 - Short circuit
 - Thermal protection
- High reliability open frame, surface-mount construction
- Open frame for improved thermal management
- UL 60950 (US and Canada), VDE 0805, CB scheme (IEC950), CE Mark (EN60950)
- Multiple patents

Optional Features:

- Latched output over voltage protection
- Latched output over current protection
- Latched over temperature protection

Ordering information:

Product Identifier	Package Size	Platform	Input Voltage	Output Current/Power	Output Units	Main Output Voltage	# of Outputs		Mechanical Feature	Electrical Feature Set
i	H	G	48	080	A	015	V	-	0	02
TDK Innoveta	Half Brick	Xeta®	36-75V	80	Amps	015 – 1.5V	Single		0 - No base plate 1- With base plate	02-R Standard, RoHS Compliant

Feature Set	On/Off Logic	Omit pin3	Output OVP	Output OCP	OTP	Pin Length	Base-plate
000	Positive	Yes	Latching	Auto-Recovery	Auto-Recovery	0.145"	No
001	Negative	Yes	Latching	Auto-Recovery	Auto-Recovery	0.145"	No
002	Positive	Yes	Auto-Recovery	Auto-Recovery	Auto-Recovery	0.145"	No
003	Negative	Yes	Auto-Recovery	Auto-Recovery	Auto-Recovery	0.145"	No



OVP: Over Voltage Protection; OCP: Over Current Protection; OTP: Over Temperature Protection.

Product Offering:

Code	Input Voltage	Output Voltage	Output Current	Maximum Output Power	Efficiency
iHG48080A015V-002-R	36V to 75V	1.5V	80A	120W	83.5%

TDK Innoveta Inc
 3320 Matrix Drive, Suite 100
 Richardson, Texas 75082

Phone (877) 498-0099 Toll Free
 (469) 916-4747
 Fax (877) 498-0143 Toll Free
 (214) 239-3101
support@tdkinnoveta.com
<http://www.tdkinnoveta.com/>

Mechanical Specification:

Dimensions are in mm [in]. Unless otherwise specified tolerances are: x.x ± 0.5 [0.02], x.xx and x.xxx ± 0.25 [0.010].

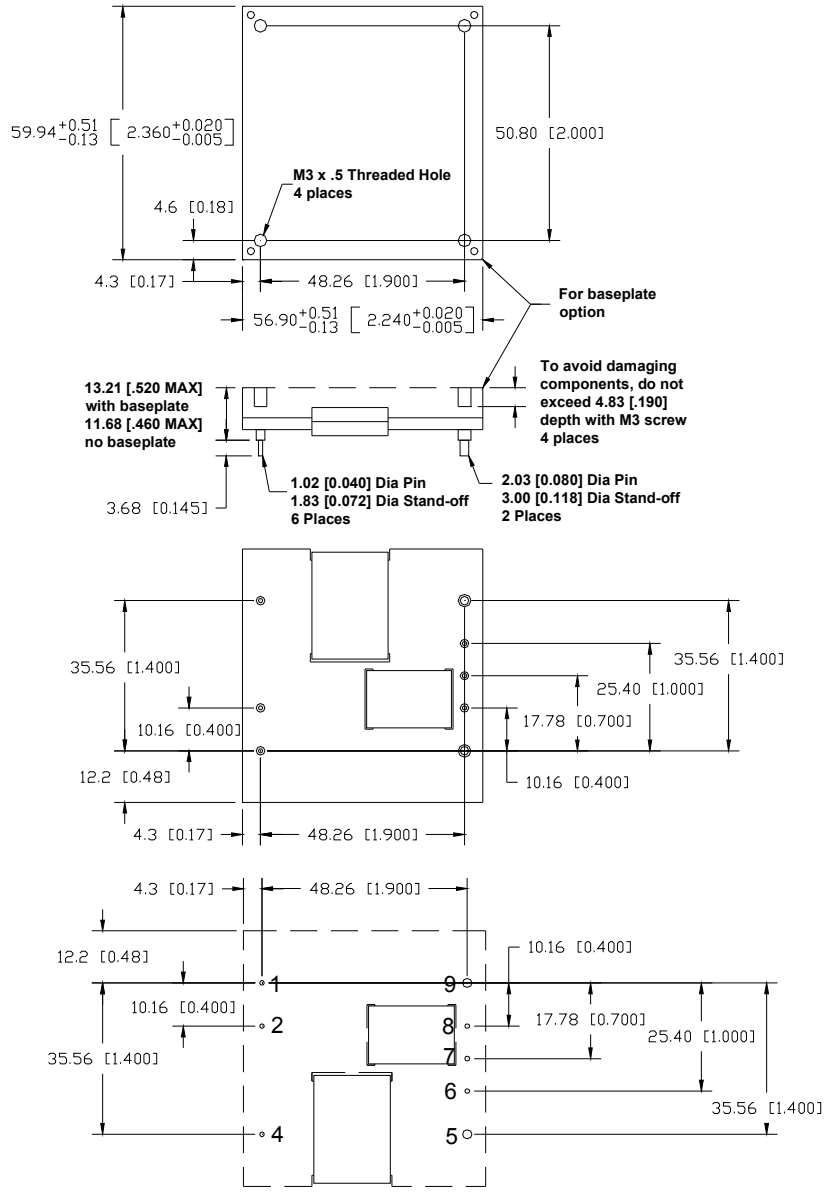

Recommended hole pattern (top view)

Pin Assignment:

PIN	FUNCTION	PIN	FUNCTION
1	Vin (+)	6	Sense (-)
2	On/Off	7	Trim
3	N/A	8	Sense (+)
4	Vin (-)	9	Vout (+)
5	Vout (-)		

Pin base material is brass (.040"Dia) and copper (.080"Dia) with gold plating. The maximum module weight without baseplate is 54g.

Absolute Maximum Ratings:

Stress in excess of Absolute Maximum Ratings may cause permanent damage to the device.

Characteristic	Min	Max	Unit	Notes & Conditions
Continuous Input Voltage	-0.5	80	Vdc	
Transient Input Voltage	---	100	Vdc	100mS max.
Isolation Voltage	---	1500	Vdc	
Storage Temperature	-55	125	°C	
Operating Temperature Range (Tc)	-40	126	°C	Measured at the location specified in the thermal measurement figure.

* Engineering estimate

Input Characteristics:

Unless otherwise specified, specifications apply over all Rated Input Voltage, Resistive Load, and Temperature conditions.

Characteristic	Min	Typ	Max	Unit	Notes & Conditions
Operating Input Voltage	36	48	75	Vdc	
Maximum Input Current	---	4.1	5	A	Vin = 0 to Vin,max, Io,max, Vo=Vo,nom
Turn-on Voltage	---	34.2	36	Vdc	
Turn-off Voltage	---	32.4	---	Vdc	
Hysteresis	---	1.8	---	Vdc	
Startup Delay Time from application of input voltage	---	18	---	mS	Vo = 0 to 0.1*Vo,nom; on/off =on, Io=Io,max, Tc=25°C
Startup Delay Time from on/off	---	5	---	mS	Vo = 0 to 0.1*Vo,nom; Vin = Vi,nom, Io=Io,max, Tc=25°C
Output Voltage Rise Time	---	22	---	mS	Io=Io,max, Tc=25°C, Vo=0.1 to 0.9*Vo,nom
Standby Current	0	5	7	mA	Vin=0V to Vin,max and module on/off pin is in 'off' state
Inrush Transient	---	---	0.1	A ² s	
Input Reflected Ripple	---	---	---	mApp	See input/output ripple measurement figure; BW = 20 MHz
Input Ripple Rejection	---	70	---	dB	@120Hz

* Engineering Estimate

Caution: The power modules are not internally fused. An external input line normal blow fuse with a maximum value of 15A is required; see the Safety Considerations section of the data sheet.

Electrical Data (continued):

Operating at Tc = 25°C unless otherwise specified

Characteristic	Min	Typ	Max	Unit	Notes & Conditions
Output Voltage Initial Setpoint	1.47	1.5	1.53	Vdc	Vin=Vin,nom; Io=Io,max
Output Voltage Tolerance	1.45	1.5	1.55	Vdc	Over all rated input voltage, load, and temperature conditions to end of life
Efficiency at 100% Load	---	83.5	---	%	Vin=Vin,nom; Io=Io,max
Efficiency at 75% Load (60A)	---	86	---	%	Vin=Vin,nom; Io=Io,max
Line Regulation	---	1	4*	mV	Vin=Vin,min to Vin,max
Load Regulation	---	4	8*	mV	Io=Io,min to Io,max
Temperature Regulation	---	10	30*	mV	Tc=Tc,min to Tc,max
Output Current	0	---	80	A	At Io < 20% of Io,max, the load transient performance may degrade slightly
Output Current Limiting Threshold	---	86.5	---	A	Vo = 0.9*Vo,nom, Tc < Tc,max
Short Circuit Current	---	2	---	A	Vo = 0.25V, Tc = 25C (hiccup mode)
Output Ripple and Noise Voltage	---	35	80*	mVpp	Vin=48V and Tc=25°C. Measured across one 10uF, one 0.47uF, one 0.1uF ceramic capacitors, and one 220uF electrolytic capacitor – see input/output ripple measurement figure; BW = 20MHz
	---	5.6	---	mVrms	
Output Voltage Adjustment Range	50	---	110	%Vo,nom	
Output Voltage Sense Range	---	---	---	%Vo,nom	
Dynamic Response: Recovery Time	---	300	---	µS	Vin=Vin,nom; load step from 50% to 75% of Io,max, di/dt = 1A/uS, with at least one 0.1uF, one 0.47uF, one 10uF ceramic capacitors, and 220uF electrolytic capacitor across the output terminals For applications with large step load changes and/or high di/dt load changes, please contact TDK Innoveta for support.
Transient Voltage	---	65	---	mV	
Output Voltage Overshoot during startup	0	0	0	mV	Io=Io,max
Switching Frequency	---	110	---	kHz	Fixed
Output Over Voltage Protection	---	2.1	2.4*	V	All line, load, and temperature conditions
External Load Capacitance	230	---	60,000**	uF	All charge and pre-bias start conditions. Cext,min required for the 100% load dump. Minimum ESR > 2 mΩ
Isolation Capacitance	---	2000	---	pF	All line, load, and temperature conditions
Isolation Resistance	15	---	---	MΩ	All line, load, and temperature conditions
Vref		1.225		V	Required for trim calculation

* Engineering Estimate

** Contact TDK Innoveta for applications that require additional capacitance

Electrical Characteristics:

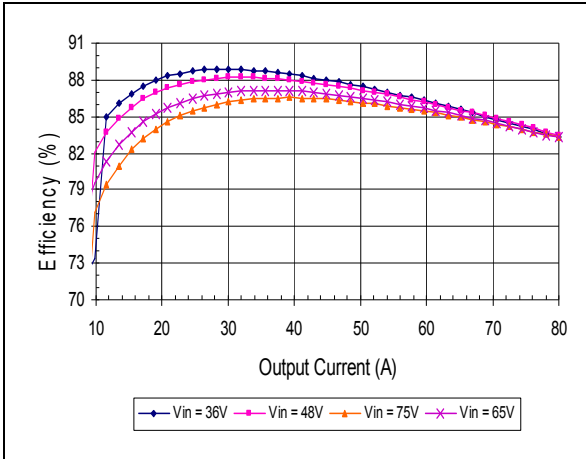

Typical Efficiency vs. Vin (test in socket, no base-plate)

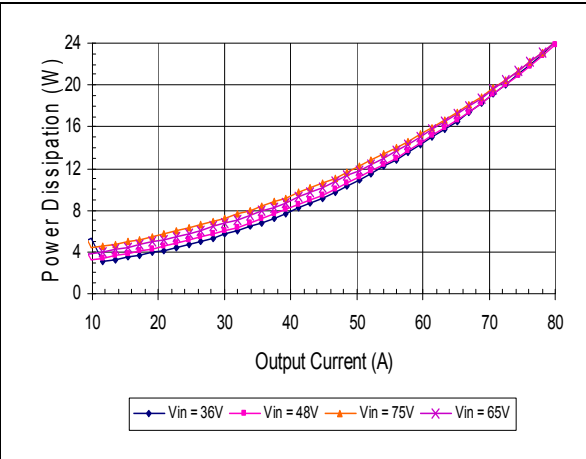

Power Dissipation vs. Vin (Test in socket, no baseplate)

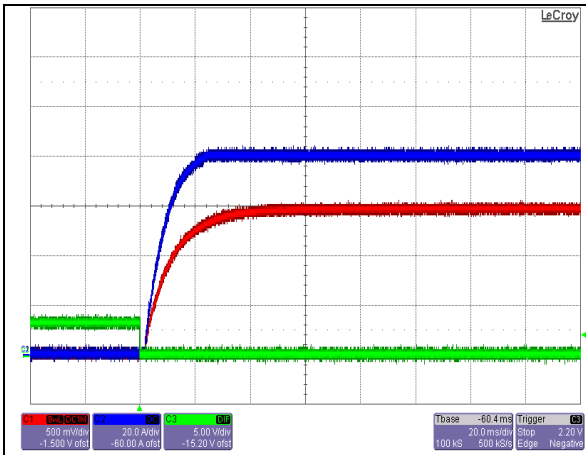

Start-up from on/off Switch at 48V input and Full Load.
Ch. 1: Vo Ch. 2: Io Ch. 3: ON/OFF

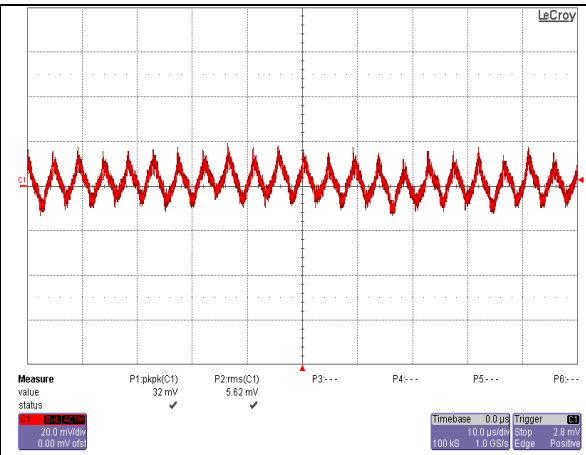

Typical Output Ripple at 48V Input and Full Load at Ta=25C
Ch. 1: Vo

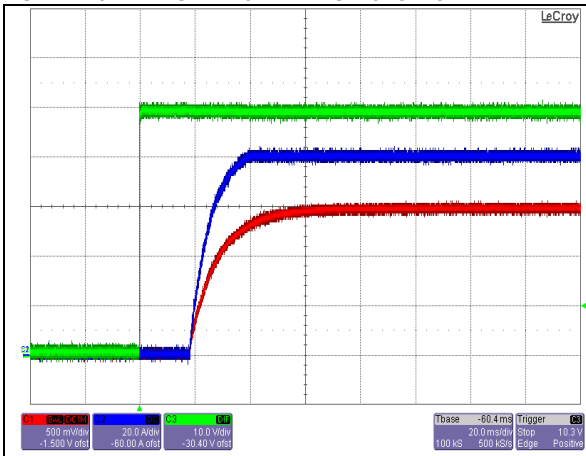

Start-up from Input Voltage Application at Full Load.
Ch. 1: Vo Ch. 2: Io Ch. 3: Vin

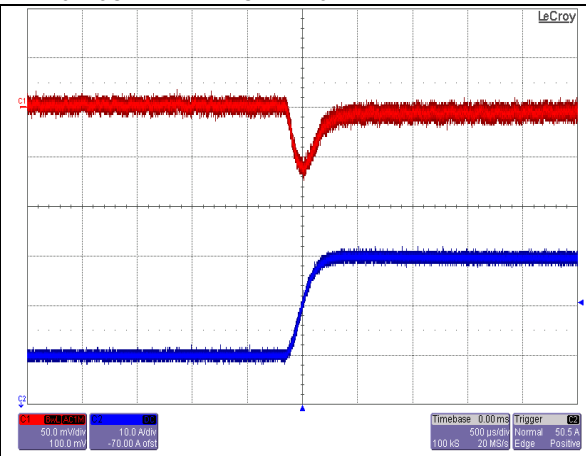

Load Transient Response. Load Step from 50% to 75% of Full Load with di/dt= 1A/uS. Ch. 1: Vo Ch. 2: Io

Electrical Characteristics (continued):

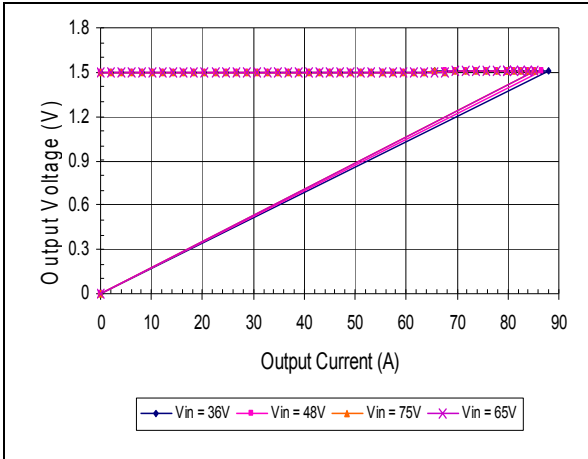

Output Current Limit Characteristics vs. Input Voltage

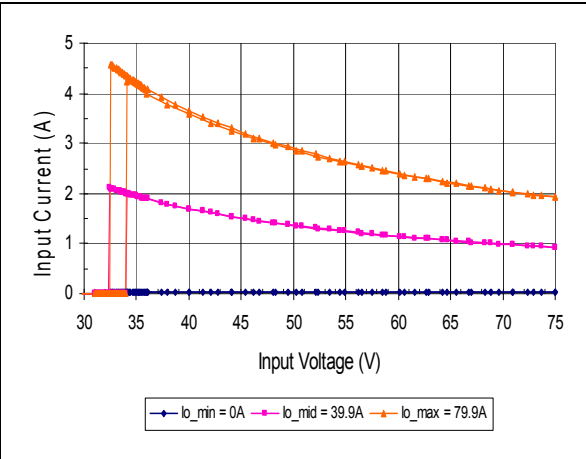

Typical Input Current vs. Input Voltage Characteristics

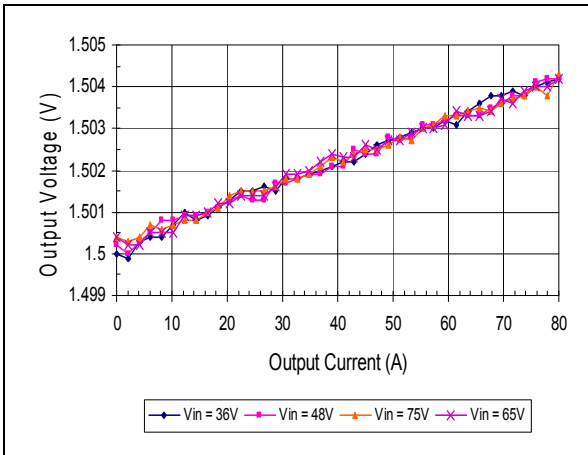

Typical Output Voltage vs. Load Current at Ta=25C.

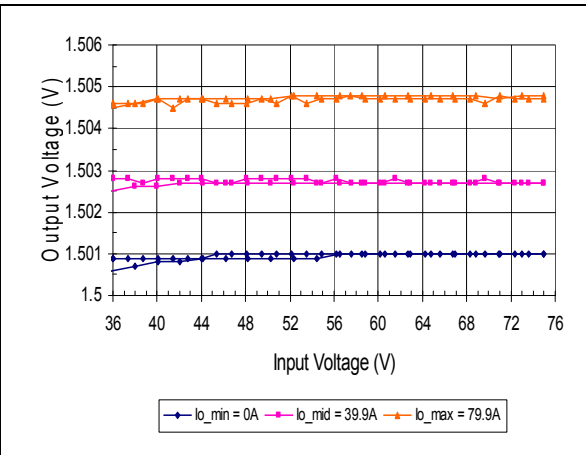

Typical Output Voltage vs. Input Voltage at Ta=25C.

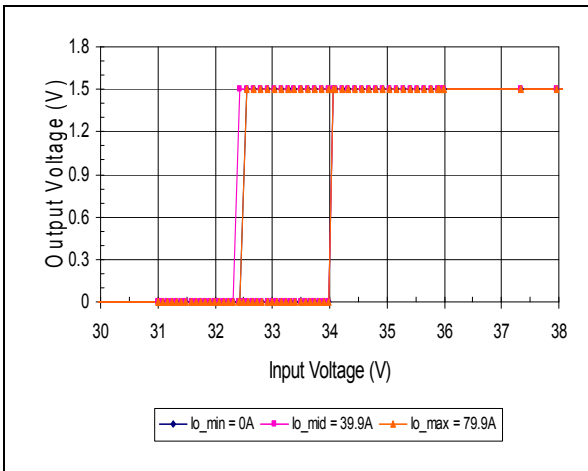

Typical Output Voltage vs. Low Voltage Input Turn-on and Turn-off at Ta=25C

% Change of Vout	Trim Down Resistor (Kohm)	% Change of Vout	Trim Up Resistor (Kohm)
-3%	31.33K	+3%	6.71K
-5%	18K	+5%	3.71K
-10%	8K	+10%	1.47K

e.g. trim up 5%

$$R_{up} = \frac{\left[\frac{1.5}{1.225} - 2 \right] \cdot (1 + 5\%) + 1}{5\%} \quad (\text{K}\Omega)$$

Calculated Resistor Values for Output Voltage Adjustment

Electrical Characteristics (continued):

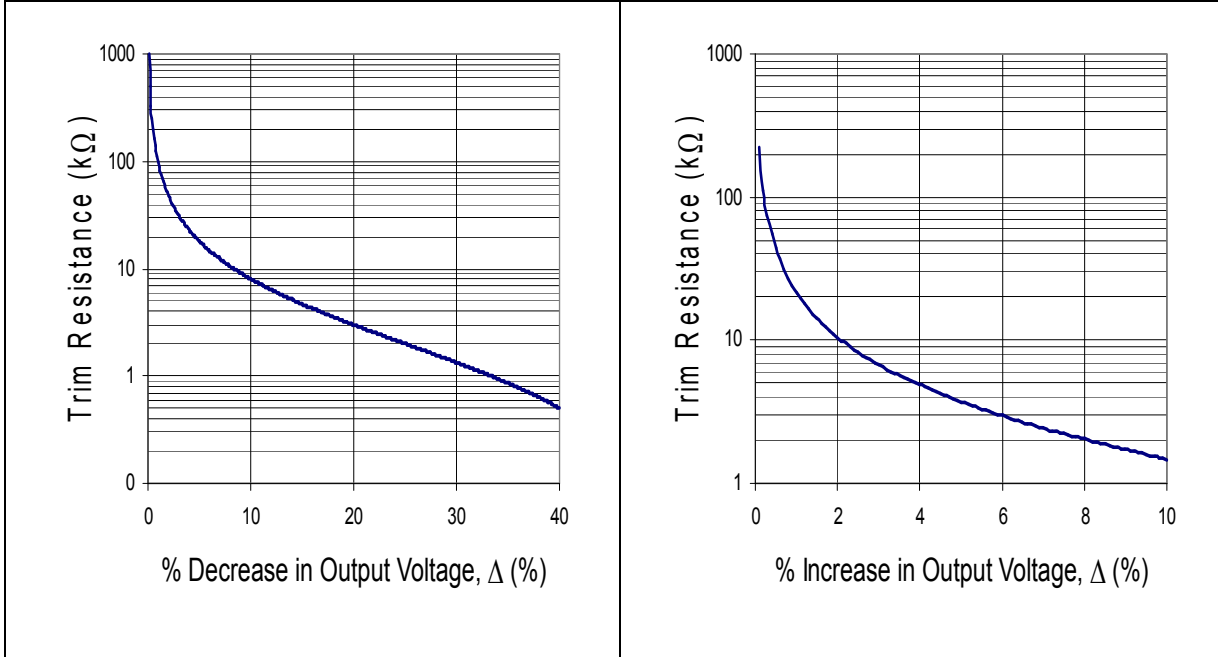

Output Trim down curve for output voltage adjustment

Trim up curve for output voltage adjustment

Thermal Performance:

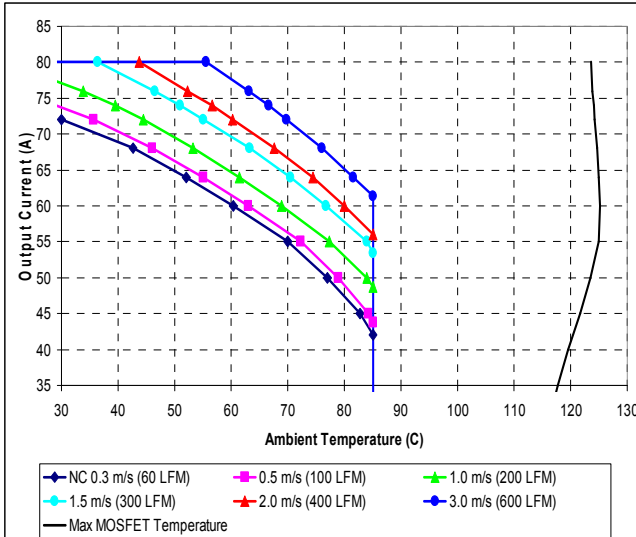

Maximum output current vs. ambient temperature at nominal input voltage **with no baseplate** for airflow rates natural convection (0.3m/s) to 3.0m/s with airflow from pin 4 to pin 1.

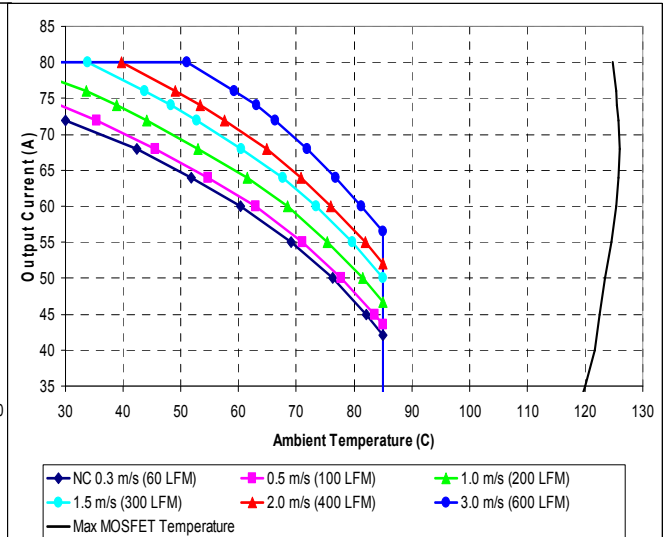

Maximum output current vs. ambient temperature at nominal input voltage **with no baseplate** for airflow rates natural convection (0.3m/s) to 3.0m/s with airflow from pin 1 to pin 4.

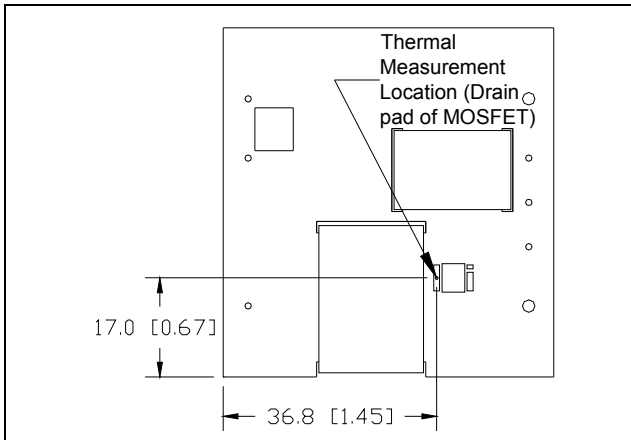

Thermal measurement location – top view

The thermal curves provided are based upon measurements made in TDK Innoveta's experimental test setup that is described in the Thermal Management section. Due to the large number of variables in system design, TDK Innoveta recommends that the user verify the module's thermal performance in the end application. The critical component should be thermo-coupled and monitored, and should not exceed the temperature limit specified in the derating curve above. It is critical that the thermocouple be mounted in a manner that gives direct thermal contact otherwise significant measurement errors may result.

Thermal Management:

An important part of the overall system design process is thermal management; thermal design must be considered at all levels to ensure good reliability and lifetime of the final system. Superior thermal design and the ability to operate in severe application environments are key elements of a robust, reliable power module.

A finite amount of heat must be dissipated from the power module to the surrounding environment. This heat is transferred by the three modes of heat transfer: convection, conduction and radiation. While all three modes of heat transfer are present in every application, convection is the dominant mode of heat transfer in most applications. However, to ensure adequate cooling and proper operation, all three modes should be considered in a final system configuration.

The open frame design of the power module provides an air path to individual components. This air path improves convection cooling to the surrounding environment, which reduces areas of heat concentration and resulting hot spots.

Test Setup: The thermal performance data of the power module is based upon measurements obtained from a wind tunnel test with the setup shown in the wind tunnel figure. This thermal test setup replicates the typical thermal environments encountered in most modern electronic systems with distributed power architectures. The electronic equipment in networking, telecom, wireless, and advanced computer systems operates in similar environments and utilizes vertically mounted printed circuit boards (PCBs) or circuit cards in cabinet racks.

The power module is mounted on a 0.087 inch thick, 12-layer, 2oz/layer PCB and is vertically oriented within the wind tunnel. Power is routed on the internal layers of the PCB. The outer copper layers are thermally decoupled from the converter to better simulate the customer's application. This also results in a more conservative derating.

The cross section of the airflow passage is rectangular with the spacing between the top of the module and a parallel facing PCB kept at a constant (0.5 in). The power module's orientation with respect to the airflow direction can have a significant impact on the unit's thermal performance.

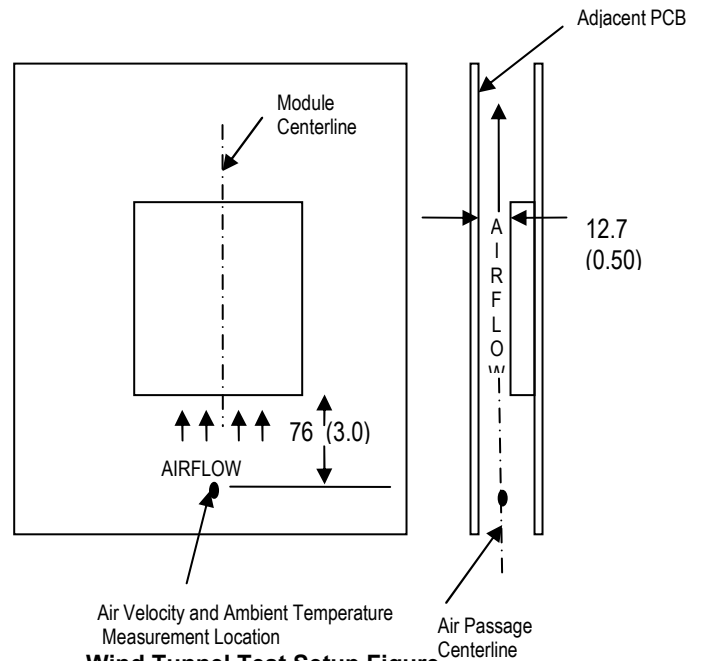

Wind Tunnel Test Setup Figure
Dimensions are in millimeters (inches)

Thermal Derating: For proper application of the power module in a given thermal environment, output current derating curves are provided as a design guideline in the Thermal Performance section for the power module of interest. The module temperature should be measured in the final system configuration to ensure proper thermal management of the power module. For thermal performance verification, the module temperature should be measured at the location indicated in the thermal measurement location figure in the Thermal Performance section for the power module of interest. In all conditions, the power module should be operated below the maximum operating temperature shown on

the derating curve. For improved design margins and enhanced system reliability, the power module may be operated at temperatures below the maximum rated operating temperature.

Heat transfer by convection can be enhanced by increasing the airflow rate that the power module experiences. The maximum output current of the power module is a function of ambient temperature (T_{AMB}) and airflow rate as shown in the thermal performance figures on the thermal performance page for the power module of interest. The curve in the figures is shown for natural convection and up. The data for the natural convection condition has been collected at 0.3 m/s (60 ft/min) of airflow, which is the typical airflow generated by other heat dissipating components in many of the systems that these types of modules are used in. In the final system configurations, the airflow rate for the natural convection condition can vary due to temperature gradients from other heat dissipating components.

Operating Information:

Over-Current-Protection (OCP): The power modules have current limit protection to protect the module during output overload and short circuit conditions. During overload conditions, the power modules may protect themselves by entering a hiccup current limit mode. The modules will operate normally once the output current returns to the specified operating range. A latched over-current protection option is also available. Consult the TDK Innoveta technical support for details.

Output Over-Voltage-Protection (OVP): The power modules have a control circuit, independent of the main control loop, that reduces the risk of over voltage appearing at the output of the power module during a fault condition. If there is a fault in the voltage regulation loop, the over voltage protection circuitry will cause the power module to shut down. The module will try to auto re-start in 1 +/- 0.2 sec time period. An optional feature with latched OVP protection can also be offered. Consult the TDK Innoveta technical support for details.

Thermal Protection: When the power modules exceed the maximum operating temperature, the modules may turn-off to safeguard the power unit against thermal damage. The module will auto restart as the unit is cooled below the over temperature threshold. A latched over-temperature protection option is also available. Consult the TDK Innoveta technical support for details.

Remote On/Off: - The power modules have an internal remote on/off circuit. The user must supply an open-collector or compatible switch between the Vin(-) pin and the on/off pin. The maximum voltage generated by the power module at the on/off terminal is 15V. The maximum allowable leakage current of the switch is 50uA. The switch must be capable of maintaining a low signal Von/off < 0.8V while sinking 400uA.

The standard on/off logic is positive logic. The power module will turn on if terminal 2 is left open and will be off if terminal 2 is connected to terminal 4. An optional negative logic is available. The power module will turn on if terminal 2 is connected to terminal 4, and it will be off if terminal 2 is left open.

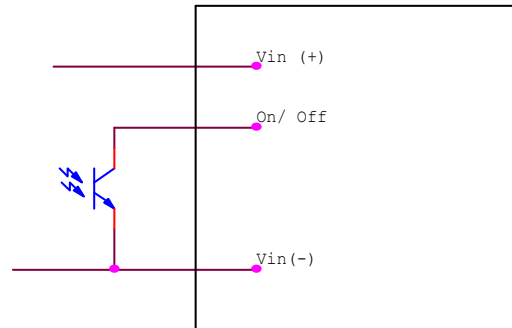

An On/Off Control Circuit

Output Voltage Adjustment: The output voltage of the power module may be adjusted by using an external resistor connected between the Vout trim terminal (pin 7) and either the Sense (+) or Sense (-) terminal. If the output voltage adjustment feature is not used, pin 7 should be left open. Care should be taken to avoid injecting noise into the power module's trim pin. A small 0.01uF capacitor between the power module's trim pin and Sense (-) pin may help to avoid this.

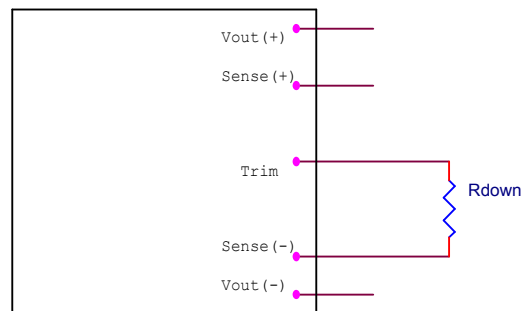

Circuit to decrease output voltage

With a resistor between the trim and Sense (-) terminals, the output voltage is adjusted down. To adjust the output voltage down a percentage of Vout (%Vo) from Vo,nom, the trim resistor should be chosen according to the following equation:

$$R_{down} = \left(\frac{100\%}{\Delta_{down}} - 2 \right) \text{ k}\Omega$$

where

$$\Delta_{down} = \frac{V_{nom} - V_{desired}}{V_{nom}} \cdot 100\%$$

The current limit set point does not increase as the module is trimmed down, so the available output power is reduced.

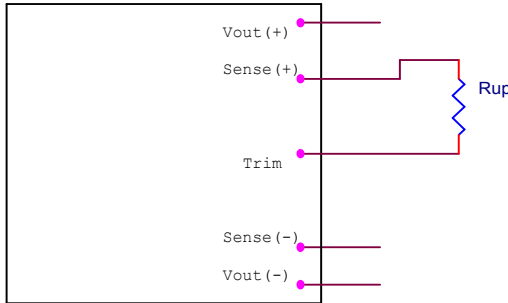

Circuit to increase output voltage

With a resistor between the trim and sense (+) terminals, the output voltage is adjusted up. To adjust the output voltage up a percentage of Vout (%Vo) from Vo,nom the trim resistor should be chosen according to the following equation:

$$R_{up} = \frac{\left[\frac{V_{nom}}{V_{ref}} - 2 \right] \cdot (1 + \Delta_{up}) + 1}{\Delta_{up}} \text{ k}\Omega$$

where

$$\Delta_{up} = \frac{V_{desired} - V_{nom}}{V_{nom}} \cdot 100\% \text{ and}$$

The value of Vref is found in the Electrical Data section for the power module of interest. Trim up and trim down curves are found in the

Electrical Characteristics section for the power module of interest.

The maximum power available from the power module is fixed. As the output voltage is trimmed up, the maximum output current must be decreased to maintain the maximum rated power of the module.

As the output voltage is trimmed, the output over-voltage set point is not adjusted. Trimming the output voltage too high may cause the output over voltage protection circuit to be triggered.

Remote Sense: The power modules feature remote sense to compensate for the effect of output distribution drops. The output voltage sense range defines the maximum voltage allowed between the output power terminals and output sense terminals, and it is found on the electrical data page for the power module of interest. If the remote sense feature is not being used, the Sense(+) terminal should be connected to the Vo(+) terminal and the Sense (-) terminal should be connected to the Vo(-) terminal. The output voltage at the Vo(+) and Vo(-) terminals can be increased by either the remote sense or the output voltage adjustment feature. The maximum voltage increase allowed is the larger of the remote sense range or the output voltage adjustment range; it is not the sum of both.

As the output voltage increases due to the use of the remote sense, the maximum output current must be decreased for the power module to remain below its max power rating.

EMC Considerations: TDK Innoveta power modules are designed for use in a wide variety of systems and applications. For assistance with designing for EMC compliance, please contact TDK Innoveta technical support.

Input Impedance: The source impedance of the power feeding the DC/DC converter module will interact with the DC/DC converter. To minimize the interaction, a 220-470uF input electrolytic capacitor should be present.

Input/Output Ripple and Noise Measurements:

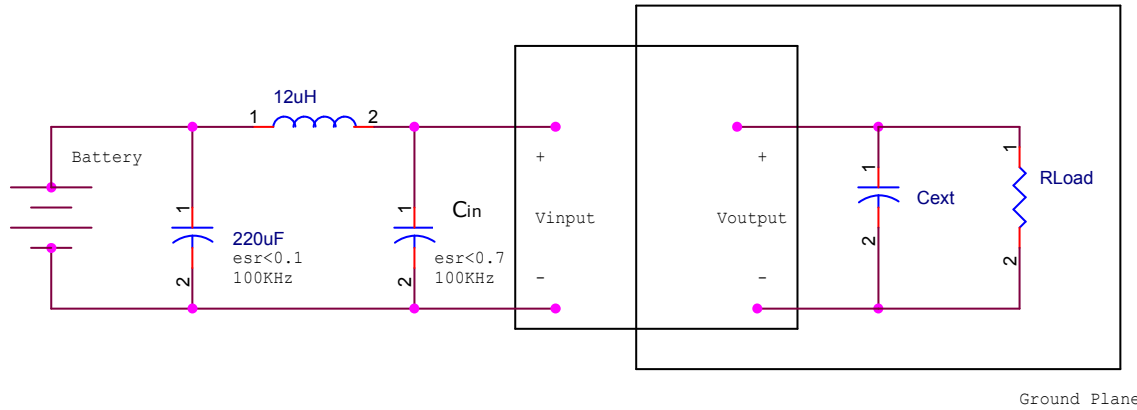

The input reflected ripple is measured with a current probe and oscilloscope. The ripple current is the current through the 12uH inductor. The capacitor C_{in} shall be at least 100uF/100V. One 220uF or two 100uF/100V capacitors in parallel are recommended.

The output ripple measurement is made approximately 9 cm (3.5 in.) from the power module using an oscilloscope and BNC socket. The capacitor C_{ext} is located about 5 cm (2 in.) from the power module; its value varies from code to code and is found on the electrical data page for the power module of interest under the ripple & noise voltage specification in the Notes & Conditions column.

Safety Considerations:

All TDK Innoveta products are certified to regulatory standards by an independent, Certified Administrative Agency laboratory. UL 1950, 3rd edition (US & Canada), and other global certifications are typically obtained for each product platform.

Various safety agency approvals are pending on the iHG product family. For safety agency approval of the system in which the DC-DC power module is installed, the power module must be installed in compliance with the creepage and clearance requirements of the safety agency. The isolation is basic insulation. For applications requiring basic insulation, care must be taken to maintain minimum creepage and clearance distances when routing traces near the power module.

As part of the production process, the power modules are hi-pot tested from primary and secondary at a test voltage of 1500Vdc. The case pin is considered a primary pin for the purpose of hi-pot testing.

When the supply to the DC-DC converter is less than 60Vdc, the power module meets all of the requirements for SELV. If the input voltage is a hazardous voltage that exceeds 60Vdc, the output can be considered SELV only if the following conditions are met:

- 1) The input source is isolated from the ac mains by reinforced insulation.
- 2) The input terminal pins are not accessible.
- 3) One pole of the input and one pole of the output are grounded or both are kept floating.
- 4) Single fault testing is performed on the end system to ensure that under a single fault, hazardous voltages do not appear at the module output.

To preserve maximum flexibility, the power modules are not internally fused. An external input line normal blow fuse with the maximum rating stipulated in the Electrical Data section is required by safety agencies. A lower value fuse can be selected based upon the maximum dc input current and maximum inrush energy of the power module.



Reliability:

The power modules are designed using TDK Innoveta's stringent design guidelines for component derating, product qualification, and design reviews. Early failures are screened out by both burn-in and an automated final test. The MTBF is calculated to be greater than 3M hours using the Telcordia TR-332 calculation method.

Improper handling or cleaning processes can adversely affect the appearance, testability, and reliability of the power modules. Contact TDK Innoveta technical support for guidance regarding proper handling, cleaning, and soldering of TDK Innoveta's power modules.

Quality:

TDK Innoveta's product development process incorporates advanced quality planning tools such as FMEA and Cpk analysis to ensure designs are robust and reliable. All products are assembled at ISO certified assembly plants.

Warranty:

TDK Innoveta's comprehensive line of power solutions includes efficient, high-density DC-DC converters. TDK Innoveta offers a three-year limited warranty. Complete warranty information is listed on our web site or is available upon request from TDK Innoveta.

TDK Innoveta Inc.

3320 Matrix Drive, Suite 100
Plano, Texas 75082

Phone (877) 498-0099 Toll Free
(469) 916-4747

Fax (877) 498-0143 Toll Free
(214) 239-3101

support@tdkinnoveta.com
<http://www.tdkinnoveta.com/>

Information furnished by TDK Innoveta is believed to be accurate and reliable. However, TDK Innoveta assumes no responsibility for its use, nor for any infringement of patents or other rights of third parties, which may result from its use. No license is granted by implication or otherwise under any patent or patent rights of TDK Innoveta. TDK Innoveta components are not designed to be used in applications, such as life support systems, wherein failure or malfunction could result in injury or death. All sales are subject to TDK Innoveta's Terms and Conditions of Sale, which are available upon request. Specifications are subject to change without notice.